





Linia narzędzi ręcznych o dobrej jakości i bardzo przystępnej cenie. Bogaty asortyment obejmuje różnego rodzaju i zastosowania: wiertła, dłuta, tarcze, nasadki, przedłużki, klucze, młotki, i wiele innych. Z naszego doświadczenia wynika, iż narzędzia tej właśnie marki cieszą się ogromnym powodzeniem zarówno wśród klientów polskich jak i zagranicznych.



Wiertło do betonu z podwójną spiralą

Masonry drill bit with double flute
Сверло по бетону с двойной спиралью
Betonbohrer mit Doppelspirale
Vrták do betónu s dvojitou špirálou



Nr. ref.	Dane techniczne	Kod EAN
CON-5/110	5,0 x 110 mm	5902143103547
CON-5/160	5,0 x 160 mm	5902143104391
CON-5/210	5,0 x 210 mm	5902143125655
CON-6/110	6,0 x 110 mm	5902143103608
CON-6/160	6,0 x 160 mm	5902143103509
CON-6/210	6,0 x 210 mm	5902143103516
CON-6/260	6,0 x 260 mm	5902143103554
CON-6/310	6,0 x 310 mm	5902143120162
CON-6,5/160	6,5 x 160 mm	5902143128298
CON-6,5/210	6,5 x 210 mm	5902143128304
CON-6,5/260	6,5 x 260 mm	5902143128311
CON-6,5/310	6,5 x 310 mm	5902143128328
CON-8/110	8,0 x 110 mm	5902143103615
CON-8/160	8,0 x 160 mm	5902143102014
CON-8/210	8,0 x 210 mm	5902143102083
CON-8/260	8,0 x 260 mm	5902143102090
CON-8/310	8,0 x 310 mm	5902143102106
CON-10/110	10,0 x 110 mm	5902143102113
CON-10/160	10,0 x 160 mm	5902143102052
CON-10/210	10,0 x 210 mm	5902143104421
CON-10/260	10,0 x 260 mm	5902143102564
CON-10/310	10,0 x 310 mm	5902143120179
CON-10/410	10,0 x 410 mm	5902143102588
CON-10/600	10,0 x 600 mm	5902143102571
CON-10/1000	10,0 x 1000 mm	5902143119456
CON-12/160	12,0 x 160 mm	5902143104414
CON-12/210	12,0 x 210 mm	5902143102489
CON-12/260	12,0 x 260 mm	5902143102472
CON-12/310	12,0 x 310 mm	5902143120186
CON-12/400	12,0 x 400 mm	5902143100447
CON-12/600	12,0 x 600 mm	5902143103479
CON-12/1000	12,0 x 1000 mm	5902143119296
CON-14/160	14,0 x 160 mm	5902143128496
CON-14/210	14,0 x 210 mm	5902143102045
CON-14/260	14,0 x 260 mm	5902143100300
CON-14/310	14,0 x 310 mm	5902143120193
CON-14/400	14,0 x 410 mm	5902143110897
CON-14/600	14,0 x 600 mm	5902143113140
CON-14/1000	14,0 x 1000 mm	5902143119463
CON-16/210	16,0 x 210 mm	5902143107682
CON-16/260	16,0 x 260 mm	5902143107699
CON-16/310	16,0 x 310 mm	5902143120209
CON-16/400	16,0 x 410 mm	5902143107705
CON-16/600	16,0 x 600 mm	5902143113157
CON-16/1000	16,0 x 1000 mm	5902143119470
CON-18/210	18,0 x 210 mm	5902143107712
CON-18/260	18,0 x 260 mm	5902143107729
CON-18/310	18,0 x 310 mm	5902143120216
CON-18/400	18,0 x 400 mm	5902143107736
CON-18/600	18,0 x 600 mm	5902143113164
CON-18/1000	18,0 x 1000 mm	5902143119487
CON-20/210	20,0 x 210 mm	5902143117827
CON-20/260	20,0 x 260 mm	5902143107743
CON-20/310	20,0 x 310 mm	5902143120223
CON-20/400	20,0 x 400 mm	5902143107750
CON-20/600	20,0 x 600 mm	5902143113171
CON-20/1000	20,0 x 1000 mm	5902143119494
CON-22/210	22,0 x 210 mm	5902143117834

CON-22/260	22,0 x 260 mm	5902143117780
CON-22/310	22,0 x 310 mm	5902143120230
CON-22/460	22,0 x 460 mm	5902143117797
CON-22/600	22,0 x 600 mm	5902143102724
CON-22/1000	22,0 x 1000 mm	5902143119500
CON-25/210	25,0 x 210 mm	5902143117841
CON-25/260	25,0 x 260 mm	5902143117803
CON-25/310	25,0 x 310 mm	5902143120247
CON-25/460	25,0 x 460 mm	5902143117810
CON-25/600	25,0 x 600 mm	5902143112297
CON-25/1000	25,0 x 1000 mm	5902143119517



Wiertła do betonu z podwójną spiralą

Masonry drill bits with double flute
Свёрла по бетону с двойной спиралью
Betonbohrer mit Doppelspirale
Vrtáky do betónu s dvojitou špirálou



Nr. ref.	Dane techniczne	Kod EAN
CON-SDS-Z3	5/6 x 110 mm; 8 x 160 mm - 3 szt.	5902143110910
CON-SDS-Z5	5/6 x 110 mm; 6/8/10 x 160 mm - 5 szt.	5902143110927
CON-SDS-Z8	5/6/8/10 x 110 mm - 8 szt.; 5/6/8/10 x 160 mm - 8 szt.	5902143113133



Wiertło do betonu z podwójną spiralą

Masonry drill bit with double flute
Сверло по бетону с двойной спиралью
Betonbohrer mit Doppelspirale
Vrták do betónu s dvojitou špirálou



Nr. ref.	Dane techniczne	Kod EAN
CON-SDSM-12x340	12 x 340 mm	5902143127970
CON-SDSM-14x340	14 x 340 mm	5902143127987
CON-SDSM-16x340	16 x 340 mm	5902143127994
CON-SDSM-18x340	18 x 340 mm	5902143128007
CON-SDSM-20x505	20 x 505 mm	5902143128014
CON-SDSM-22x505	22 x 505 mm	5902143128021
CON-SDSM-25x505	25 x 505 mm	5902143128038
CON-SDSM-28x505	28 x 505 mm	5902143128045
CON-SDSM-30x505	30 x 505 mm	5902143128052



Punktak

Centre punch
Кернер
Körner
Jamkár



Nr. ref.	Dane techniczne	Kod EAN
CON-P1-14-250	14 x 250 mm	5902143109235
CON-P1-17-280	17 x 280 mm	5902143109242



Szpicak

Point chisel
Шпунт
Spitzeisen
Sekáč špicatý



Nr. ref.	Dane techniczne	Kod EAN
CON-SDSM-CP280	18 x 280 mm	5902143128069
CON-SDSM-CP400	18 x 400 mm	5902143128076
CON-SDSM-CP600	18 x 600 mm	5902143128083



Przecinak

Cold chisel
Зубило
Meißel
Sekáč



Nr. ref.	Dane techniczne	Kod EAN
CON-P2-14-250	20 x 14 x 250 mm	5902143109259
CON-P2-17x280	20 x 17 x 280 mm	5902143109266



Dłuto płaskie

Flat chisel
Зубило плоское
Stechbeitel
Dláto ploché



Nr. ref.	Dane techniczne	Kod EAN
CON-SDSM-CF280	25 x 18 x 280 mm	5902143128090
CON-SDSM-CF400	25 x 18 x 400 mm	5902143128106
CON-SDSM-CF600	25 x 18 x 600 mm	5902143128113



Przecinak szeroki

Spade chisel
Зубило широкое
Meißel breit
Sekáč široký



Nr. ref.	Dane techniczne	Kod EAN
CON-P3-14-250	30 x 14 x 250 mm	5902143109273
CON-P3-17-280	40 x 17 x 280 mm	5902143109280



Dłuto płaskie łopatkowe

Spade chisel, long
Зубило плоское, лопаточное
Stechschaufelbeitel
Dláto ploché lyžicové



Nr. ref.	Dane techniczne	Kod EAN
CON-SDSM-CBF280	40 x 18 x 280 mm	5902143128120
CON-SDSM-CBF400	40 x 18 x 400 mm	5902143128137
CON-SDSM-CBF600	40 x 18 x 600 mm	5902143128144
CON-SDSM-CS280-50	50 x 18 x 280 mm	5902143128168



Przecinak łukowy

Gouge
Зубило полукруглое
Bogenmeißel
Sekáč oblúkový



Nr. ref.	Dane techniczne	Kod EAN
CON-P4-14x250	14 x 250 mm	5902143102694
CON-P4-17x280	17 x 280 mm	5902143122470



Dłuto wydrążone

Gouge
Зубило полое
Hohlbeitel
Dláto duté



Nr. ref.	Dane techniczne	Kod EAN
CON-SDSM-CG280	25 x 18 x 280 mm	5902143128151
CON-SDSM-CW280	60 x 18 x 280 mm	5902143128175



Adapter na uchwyt magnetyczny

Magnetic chuck adaptor
Переходник на магнитный держатель
Adapter für Magnethalter
Adaptér na magnetický úchyt



Nr. ref.	Dane techniczne	Kod EAN
CON-SDS-A1	1/4", 90 mm	5902143125280

Adapter na uchwyt wiertarski

Drill chuck adaptor
Переходник для патронов
Bohrhalter
Adaptér pre skľučovadlo



Nr. ref.	Dane techniczne	Kod EAN
CON-SDS-A2	1/2"	5902143110941

Adapter

Adaptor
Адаптер
Adapter
Adaptér



Nr. ref.	Kod EAN
CON-SDS-A3	5902143110965

Wiertło do betonu szlifowane typ B&W

Masonry drill bit, ground, B&W
Сверло по бетону, шлифованное, типа B&W
Betonbohrer geschliffen, Typ B&W
Vrták do betónu, brúsený, typ B&W



Nr. ref.	Dane techniczne	Kod EAN
CON-BD-4	4,0 mm	5902143109082
CON-BD-5	5,0 mm	5902143109099
CON-BD-6	6,0 mm	5902143109105
CON-BD-8	8,0 mm	5902143109112
CON-BD-10	10,0 mm	5902143109129
CON-BD-12	12,0 mm	5902143109136
CON-BD-200-6	6,0 x 200 mm	5902143109150
CON-BD-200-8	8,0 x 200 mm	5902143109167
CON-BD-200-10	10,0 x 200 mm	5902143109174
CON-BD-200-12	12,0 x 200 mm	5902143109181
CON-BD-200-14	14,0 x 200 mm	5902143109198
CON-BD-200-16	16,0 x 200 mm	5902143109204
CON-BD-200-18	18,0 x 200 mm	5902143109211
CON-BD-200-20	20,0 x 200 mm	5902143109228



Wiertło do betonu hartowane

Masonry drill bit, hardened
Сверло по бетону, закалённое
Betonbohrer, gehärtet
Vrták do betónu, kalený



Nr. ref.	Dane techniczne	Kod EAN
CON-BDP-03	3,0 mm	5902143115786
CON-BDP-04	4,0 mm	5902143115793
CON-BDP-05	5,0 mm	5902143115809
CON-BDP-06	6,0 mm	5902143115816
CON-BDP-07	7,0 mm	5902143120261
CON-BDP-08	8,0 mm	5902143115823
CON-BDP-09	9,0 mm	5902143120278
CON-BDP-10	10,0 mm	5902143115830
CON-BDP-12	12,0 mm	5902143115847
CON-BDP-06/200	6,0 x 200 mm	5902143120285
CON-BDP-06/300	6,0 x 300 mm	5902143120018
CON-BDP-06/400	6,0 x 400 mm	5902143120070
CON-BDP-08/200	8,0 x 200 mm	5902143120292
CON-BDP-08/300	8,0 x 300 mm	5902143120025
CON-BDP-08/400	8,0 x 400 mm	5902143120087
CON-BDP-10/200	10,0 x 200 mm	5902143120308
CON-BDP-10/300	10,0 x 300 mm	5902143120032
CON-BDP-10/400	10,0 x 400 mm	5902143120094
CON-BDP-10/600	10,0 x 600 mm	5902143120384
CON-BDP-12/200	12,0 x 200 mm	5902143120353
CON-BDP-12/300	12,0 x 300 mm	5902143120049
CON-BDP-12/400	12,0 x 400 mm	5902143120100
CON-BDP-12/600	12,0 x 600 mm	5902143120391
CON-BDP-14/200	14,0 x 200 mm	5902143120360
CON-BDP-14/300	14,0 x 300 mm	5902143120056
CON-BDP-14/400	14,0 x 400 mm	5902143120117
CON-BDP-14/600	14,0 x 600 mm	5902143120407
CON-BDP-16/200	16,0 x 200 mm	5902143120377
CON-BDP-16/300	16,0 x 300 mm	5902143120063
CON-BDP-16/400	16,0 x 400 mm	5902143120124
CON-BDP-16/600	16,0 x 600 mm	5902143120414
CON-BDP-18/400	18,0 x 400 mm	5902143120131
CON-BDP-18/600	18,0 x 600 mm	5902143120421
CON-BDP-20/400	20,0 x 400 mm	5902143120148
CON-BDP-20/600	20,0 x 600 mm	5902143120438



Wiertło do betonu

Masonry drill bit
Сверло по бетону
Betonbohrer
Vrták do betónu



Nr. ref.	Dane techniczne	Kod EAN
CON-1403	8,0/10,0/12,0 mm x 400 mm; 3 szt.	5902143133704



Wiertło do betonu

Masonry drill bit
Сверло по бетону
Betonbohrer
Vrták do betónu



Nr. ref.	Dane techniczne	Kod EAN
CON-1405	4,0-10,0 mm; 5 szt.	5902143133711
CON-1408	3,0-10,0 mm; 8 szt.	5902143133728



Wiertła do betonu hartowane

Masonry drill bits, hardened
Свёрла по бетону, закалённое
Betonbohrer, gehärtet
Vrtáky do betónu, kalený



Nr. ref.	Dane techniczne	Kod EAN
CON-BDP-Z5	4,0-10,0 mm; 5 szt.	5902143120155



Wiertła do betonu szlifowane typ B&W

Masonry drill bits, ground B&W
Свёрла по бетону, шлифованные, типа B&W
Betonbohrer geschliffen, Typ B&W
Vrtáky do betónu, brúsené, typ B&W,



Nr. ref.	Dane techniczne	Kod EAN
CON-0006	5,0-10,0 mm; 4 szt.	5902143107309



Adapter z wiertłem prowadzącym

Adaptor with pilot drill
Державка с центрирующим сверлом
Adapter mit Führungsbohrer
Adaptér so strediacim vrtákom



Nr. ref.	Dane techniczne	Kod EAN
IW-HEX-110	110 mm	5902143101413
IW-HEX-170	170 mm	5902143117575
IW-HEX-220	220 mm	5902143117599



Adapter z wiertłem prowadzącym

Adaptor with pilot drill
Державка с центрирующим сверлом
Adapter mit Führungsbohrer
Adaptér z strediacim vrtákom



Nr. ref.	Dane techniczne	Kod EAN
IW-SDS-plus-110	110 mm	5902143101420
IW-SDS-plus-170	170 mm	5902143117582
IW-SDS-plus-220	220 mm	5902143117605



Koronka wiertnicza z widią i adapterem

Core bit, tungsten carbide, adaptor
 Коронка буровая, армированная, с державкой
 Bohrkrona mit Widia und Adapter
 Korunka vrtacia vidiová, adaptér



Nr. ref.	Dane techniczne	Kod EAN
IWK-65	65 mm	5902143132011
IWK-80	80 mm	5902143132028



Koronka wiertnicza z widią i adapterem

Core bit, tungsten carbide, adaptor
 Коронка буровая, армированная, с державкой
 Bohrkrona mit Widia und Adapter
 Korunka vrtacia vidiová, adaptér



Nr. ref.	Dane techniczne	Kod EAN
IWK-S65	65 mm	5902143131991
IWK-S80	80 mm	5902143132004



Koronka wiertnicza z widią

Core bit, tungsten carbide
 Коронка буровая, армированная
 Bohrkrona mit Widia
 Korunka vrtacia vidiová



Nr. ref.	Dane techniczne	Kod EAN
IW-65	65 mm	5902143106258
IW-80	80 mm	5902143106289



Wiertła do metalu szlifowane

Metal drill bits, ground
 Свёрла по металлу, шлифованные
 Metallbohrer, geschliffen
 Vrtáky do kovu, brúsené



Nr. ref.	Dane techniczne	Kod EAN
CON-XS-01	1,0 mm; 10 szt.	5902143113768
CON-XS-01,2	1,2 mm; 10 szt.	5902143115854
CON-XS-01,5	1,5 mm; 10 szt.	5902143113546
CON-XS-02	2,0 mm; 10 szt.	5902143113553
CON-XS-02,1	2,1 mm; 10 szt.	5902143115878
CON-XS-02,2	2,2 mm; 10 szt.	5902143115885
CON-XS-02,5	2,5 mm; 10 szt.	5902143113560
CON-XS-03	3,0 mm; 10 szt.	5902143113577
CON-XS-03,1	3,1 mm; 10 szt.	5902143115892
CON-XS-03,2	3,2 mm; 10 szt.	5902143115908
CON-XS-03,3	3,3 mm; 10 szt.	5902143115915
CON-XS-03,5	3,5 mm; 10 szt.	5902143113584
CON-XS-03,8	3,8 mm; 10 szt.	5902143115922
CON-XS-04	4,0 mm; 10 szt.	5902143113591
CON-XS-04,1	4,1 mm; 10 szt.	5902143115939
CON-XS-04,2	4,2 mm; 10 szt.	5902143113607
CON-XS-04,5	4,5 mm; 10 szt.	5902143113614
CON-XS-04,8	4,8 mm; 10 szt.	5902143115946
CON-XS-05	5,0 mm; 10 szt.	5902143113621
CON-XS-05,1	5,1 mm; 10 szt.	5902143115953
CON-XS-05,2	5,2 mm; 10 szt.	5902143115960
CON-XS-05,5	5,5 mm; 10 szt.	5902143113638
CON-XS-06	6,0 mm; 10 szt.	5902143113645
CON-XS-06,1	6,1 mm; 10 szt.	5902143115977
CON-XS-06,5	6,5 mm; 10 szt.	5902143113652
CON-XS-07	7,0 mm; 10 szt.	5902143113669
CON-XS-07,5	7,5 mm; 10 szt.	5902143113676
CON-XS-08	8,0 mm; 5 szt.	5902143113683
CON-XS-08,1	8,1 mm; 5 szt.	5902143115984
CON-XS-08,5	8,5 mm; 5 szt.	5902143113690
CON-XS-09	9,0 mm; 5 szt.	5902143113706
CON-XS-09,5	9,5 mm; 5 szt.	5902143113713
CON-XS-10	10,0 mm; 5 szt.	5902143113720
CON-XS-10,5	10,5 mm; 5 szt.	5902143115861
CON-XS-11	11,0 mm; 5 szt.	5902143113737
CON-XS-12	12,0 mm; 5 szt.	5902143113744
CON-XS-13	13,0 mm; 5 szt.	5902143113751



Wiertła do metalu szlifowane

Metal drill bits, ground
Свёрла по металлу, шлифованные
Metallbohrer, geschliffen
Vrtáky do kovu, brúsené



Nr. ref.	Dane techniczne	Kod EAN
CON-M/01	1,0 mm; 3 szt.	5902143107415
CON-M/01,5	1,5 mm; 3 szt.	5902143107422
CON-M/02	2,0 mm; 3 szt.	5902143107439
CON-M/02,5	2,5 mm; 2 szt.	5902143107446
CON-M/03	3,0 mm; 2 szt.	5902143107453
CON-M/03,5	3,5 mm; 2 szt.	5902143107460
CON-M/04	4,0 mm; 2 szt.	5902143107477
CON-M/04,2	4,2 mm; 2 szt.	5902143107484
CON-M/04,5	4,5 mm; 2 szt.	5902143107491
CON-M/05	5,0 mm; 2 szt.	5902143107507
CON-M/05,5	5,5 mm; 2 szt.	5902143107514
CON-M/06	6,0 mm; 2 szt.	5902143107521
CON-M/06,5	6,5 mm; 1 szt.	5902143107538
CON-M/07	7,0 mm; 1 szt.	5902143107545
CON-M/07,5	7,5 mm; 1 szt.	5902143107552
CON-M/08	8,0 mm; 1 szt.	5902143107569
CON-M/08,5	8,5 mm; 1 szt.	5902143107576
CON-M/09	9,0 mm; 1 szt.	5902143107583
CON-M/10	10,0 mm; 1 szt.	5902143107590
CON-M/11	11,0 mm; 1 szt.	5902143107606
CON-M/12	12,0 mm; 1 szt.	5902143107613
CON-M/13	13,0 mm; 1 szt.	5902143107620



CON-MLS-10,5	10,5 x 121,0 x 184,0 mm; 1 szt.	5902143118268
CON-MLS-11	11,0 x 128,0 x 195,0 mm; 1 szt.	5902143118275
CON-MLS-11,5	11,5 x 128,0 x 195,0 mm; 1 szt.	5902143118282
CON-MLS-12	12,0 x 134,0 x 205,0 mm; 1 szt.	5902143118299
CON-MLS-12,5	12,5 x 134,0 x 205,0 mm; 1 szt.	5902143118305
CON-MLS-13	13,0 x 134,0 x 205,0 mm; 1 szt.	5902143118312



Wiertła do metalu podwójnie szlifowane

Metal drill bits, fully ground
Свёрла по металлу с двойной шлифовкой
Metallbohrer, doppelt geschliffen
Vrtáky do kovu, dvojité brúsené



Nr. ref.	Dane techniczne	Kod EAN
CON-XSE-01	1,0 mm; 10 szt.	5902143122715
CON-XSE-01,5	1,5 mm; 10 szt.	5902143122722
CON-XSE-02	2,0 mm; 10 szt.	5902143122739
CON-XSE-02,5	2,5 mm; 10 szt.	5902143122746
CON-XSE-03	3,0 mm; 10 szt.	5902143122753
CON-XSE-03,2	3,2 mm; 10 szt.	5902143122760
CON-XSE-03,5	3,5 mm; 10 szt.	5902143122777
CON-XSE-04	4,0 mm; 10 szt.	5902143122784
CON-XSE-04,2	4,2 mm; 10 szt.	5902143122791
CON-XSE-04,5	4,5 mm; 10 szt.	5902143122807
CON-XSE-05	5,0 mm; 10 szt.	5902143122814
CON-XSE-05,2	5,2 mm; 10 szt.	5902143122821
CON-XSE-05,5	5,5 mm; 10 szt.	5902143122838
CON-XSE-06	6,0 mm; 10 szt.	5902143122852
CON-XSE-06,5	6,5 mm; 10 szt.	5902143122869
CON-XSE-07	7,0 mm; 10 szt.	5902143122876
CON-XSE-07,5	7,5 mm; 10 szt.	5902143122883
CON-XSE-08	8,0 mm; 5 szt.	5902143122890
CON-XSE-08,5	8,5 mm; 5 szt.	5902143122906
CON-XSE-09	9,0 mm; 5 szt.	5902143122913
CON-XSE-09,5	9,5 mm; 5 szt.	5902143122920
CON-XSE-10	10,0 mm; 5 szt.	5902143122937
CON-XSE-10,5	10,5 mm; 5 szt.	5902143122944
CON-XSE-11	11,0 mm; 5 szt.	5902143122951
CON-XSE-11,5	11,5 mm; 5 szt.	5902143122968
CON-XSE-12	12,0 mm; 5 szt.	5902143122975
CON-XSE-12,5	12,5 mm; 5 szt.	5902143122982
CON-XSE-13	13,0 mm; 5 szt.	5902143122845



Wiertła do metalu szlifowane, przedłużane

Metal drill bits, ground, long
Свёрла по металлу шлифованные, удлинённые
Metallbohrer geschliffen, verlängert
Vrtáky do kovu brúsené, predĺžované



Nr. ref.	Dane techniczne	Kod EAN
CON-MLS-01	1,0 x 33,0 x 56,0 mm; 3 szt.	5902143118039
CON-MLS-01,5	1,5 x 45,0 x 70,0 mm; 3 szt.	5902143118046
CON-MLS-02	2,0 x 56,0 x 85,0 mm; 3 szt.	5902143118053
CON-MLS-02,5	2,5 x 62,0 x 95,0 mm; 2 szt.	5902143118060
CON-MLS-03	3,0 x 66,0 x 100,0 mm; 2 szt.	5902143118077
CON-MLS-03,2	3,2 x 69,0 x 106,0 mm; 2 szt.	5902143118084
CON-MLS-03,5	3,5 x 73,0 x 112,0 mm; 2 szt.	5902143118091
CON-MLS-04	4,0 x 78,0 x 119,0 mm; 2 szt.	5902143118107
CON-MLS-04,2	4,2 x 78,0 x 119,0 mm; 2 szt.	5902143118114
CON-MLS-04,5	4,5 x 78,0 x 119,0 mm; 2 szt.	5902143118121
CON-MLS-05	5,0 x 87,0 x 132,0 mm; 2 szt.	5902143118138
CON-MLS-05,2	5,2 x 87,0 x 132,0 mm; 2 szt.	5902143118145
CON-MLS-05,5	5,5 x 87,0 x 132,0 mm; 2 szt.	5902143118152
CON-MLS-06	6,0 x 91,0 x 139,0 mm; 2 szt.	5902143118169
CON-MLS-06,2	6,2 x 97,0 x 148,0 mm; 2 szt.	5902143118176
CON-MLS-06,5	6,5 x 97,0 x 148,0 mm; 1 szt.	5902143118183
CON-MLS-07	7,0 x 102,0 x 156,0 mm; 1 szt.	5902143118190
CON-MLS-07,5	7,5 x 102,0 x 156,0 mm; 1 szt.	5902143118206
CON-MLS-08	8,0 x 109,0 x 165,0 mm; 1 szt.	5902143118213
CON-MLS-08,5	8,5 x 109,0 x 165,0 mm; 1 szt.	5902143118220
CON-MLS-09	9,0 x 115,0 x 175,0 mm; 1 szt.	5902143118237
CON-MLS-09,5	9,5 x 115,0 x 175,0 mm; 1 szt.	5902143118244
CON-MLS-10	10,0 x 121,0 x 184,0 mm; 1 szt.	5902143118251

Wiertła do metalu kobaltowe

Metal drill bits, cobalt
Свёрла по металлу, кобальтовые
Cobalt-Metallbohrer
Vrtáky do kovu, kobaltové



Nr. ref.	Dane techniczne	Kod EAN
CON-XSCO-1	1,0 mm; 10 szt.	5902143116844
CON-XSCO-1,2	1,2 mm; 10 szt.	5902143121619
CON-XSCO-1,5	1,5 mm; 10 szt.	5902143116851
CON-XSCO-2	2,0 mm; 10 szt.	5902143116868

CON-XSCO-2,1	2,1 mm; 10 szt.	5902143121626
CON-XSCO-2,2	2,2 mm; 10 szt.	5902143121633
CON-XSCO-2,5	2,5 mm; 10 szt.	5902143116875
CON-XSCO-2,8	2,8 mm; 10 szt.	5902143121640
CON-XSCO-3	3,0 mm; 10 szt.	5902143116882
CON-XSCO-3,1	3,1 mm; 10 szt.	5902143118329
CON-XSCO-3,2	3,2 mm; 10 szt.	5902143116899
CON-XSCO-3,5	3,5 mm; 10 szt.	5902143116905
CON-XSCO-3,8	3,8 mm; 10 szt.	5902143118442
CON-XSCO-4	4,0 mm; 10 szt.	5902143116912
CON-XSCO-4,1	4,1 mm; 10 szt.	5902143118459
CON-XSCO-4,2	4,2 mm; 10 szt.	5902143119586
CON-XSCO-4,5	4,5 mm; 10 szt.	5902143116929
CON-XSCO-4,8	4,8 mm; 10 szt.	5902143118466
CON-XSCO-5	5,0 mm; 10 szt.	5902143116936
CON-XSCO-5,1	5,1 mm; 10 szt.	5902143118473
CON-XSCO-5,2	5,2 mm; 10 szt.	5902143119593
CON-XSCO-5,5	5,5 mm; 10 szt.	5902143116943
CON-XSCO-6	6,0 mm; 10 szt.	5902143116950
CON-XSCO-6,2	6,2 mm; 10 szt.	5902143119906
CON-XSCO-6,5	6,5 mm; 10 szt.	5902143116967
CON-XSCO-6,8	6,8 mm; 10 szt.	5902143129011
CON-XSCO-7	7,0 mm; 10 szt.	5902143116974
CON-XSCO-7,5	7,5 mm; 10 szt.	5902143116981
CON-XSCO-8	8,0 mm; 5 szt.	5902143116998
CON-XSCO-8,5	8,5 mm; 5 szt.	5902143170001
CON-XSCO-9	9,0 mm; 5 szt.	5902143170018
CON-XSCO-9,5	9,5 mm; 5 szt.	5902143117032
CON-XSCO-10	10,0 mm; 5 szt.	5902143117049
CON-XSCO-11	11,0 mm; 5 szt.	5902143117056
CON-XSCO-12	12,0 mm; 5 szt.	5902143117063
CON-XSCO-13	13,0 mm; 5 szt.	5902143117070



Wiertła do metalu

Metal drill bits
Свёрла по металлу
Metallbohrer
Vrtáky do kovu



Nr. ref.	Dane techniczne	Kod EAN
CON-WM-1113	1,5-6,5 mm; 13 szt.	5902143107125
CON-WM-1118	2,0-8,0 mm; 13 szt.	5902143107217



Wiertła do metalu HSS TIN

Metal drill bits HSS TIN
Свёрла по металлу HSS TIN
Metallbohrer HSS TIN
Vrtáky do kovu HSS TIN



Nr. ref.	Dane techniczne	Kod EAN
CON-WM-1128	1,0-10,0 mm; 19 szt.	5902143137306



Wiertła do metalu

Metal drill bits
Свёрла по металлу
Metallbohrer
Vrtáky do kovu



Nr. ref.	Dane techniczne	Kod EAN
CON-WM-1129	1,0-10,0 mm; 19 szt.	5902143113515
CON-WM-1130	1,0-13,0 mm; 25 szt.	5902143133698



Wiertła do metalu szlifowane

Metal drill bits, ground
Свёрла по металлу, шлифованные
Metallbohrer, geschliffen
Vrtáky do kovu, brúsené



Nr. ref.	Dane techniczne	Kod EAN
CON-WMP01	1,5-6,5 mm; 13 szt.	5902143107194
CON-WMP02	2,0-8,0 mm; 13 szt.	5902143107200



Wiertło stopniowe, tytanowane

Titanium step drill bit
Свёрло ступенчатое с титановым покрытием
Stufenbohrer mit Titan-Oberflächenbehandlung
Vrták postupný, titánový



Nr. ref.	Dane techniczne	Kod EAN
CON-SD-4-12	4,0-12,0 mm	5902143119210
CON-SD-4-20	4,0-20,0 mm	5902143119227
CON-SD-4-30	4,0-30,0 mm	5902143119234
CON-SD-6-37	6,0-37,0 mm	5902143119241



Wiertło do drewna szlifowane

Wood drill bit, ground
Свёрло по дереву, шлифованное
Holzbohrer, geschliffen
Vrták do dreva, brúsený



Nr. ref.	Dane techniczne	Kod EAN
CON-D-3	3,0 mm	5902143113805
CON-D-4	4,0 mm	5902143113829
CON-D-5	5,0 mm	5902143113836
CON-D-6	6,0 mm	5902143113843
CON-D-7	7,0 mm	5902143113850
CON-D-8	8,0 mm	5902143113867
CON-D-9	9,0 mm	5902143113874
CON-D-10	10,0 mm	5902143113881
CON-D-12	12,0 mm	5902143113812
CON-D-13	13,0 mm	5902143114338

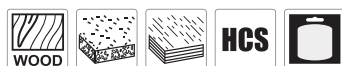

Wiertło do drewna przedłużane

Wood drill bit, long
Свёрло по дереву, удлинённое
Holzbohrer, verlängert
Vrták do dreva predĺžovaný



Nr. ref.	Dane techniczne	Kod EAN
CON-DLS-4/400	4,0 x 400 mm	5902143121909
CON-DLS-6/400	6,0 x 400 mm	5902143121916
CON-DLS-8/400	8,0 x 400 mm	5902143121923
CON-DLS-10/400	10,0 x 400 mm	5902143121930
CON-DLS-12/400	12,0 x 400 mm	5902143121947
CON-DLS-14/400	14,0 x 400 mm	5902143121954
CON-DLS-16/400	16,0 x 400 mm	5902143121961
CON-DLS-18/400	18,0 x 400 mm	5902143121978
CON-DLS-20/400	20,0 x 400 mm	5902143121985
CON-DLS-24/400	24,0 x 400 mm	5902143121992

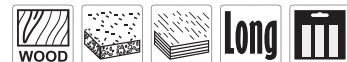

Wiertła do drewna przedłużane

Wood drill bits long
Свёрла по дереву, шлифованное
Holzbohrer, verlängert
Vrtáky do dreva, predĺžované



Nr. ref.	Dane techniczne	Kod EAN
1156	6,0-14,0 mm x 300 mm; 6 szt.	5902143118411



Wiertło do drewna kręte

Auger drill bit for wood
Свёрло по дереву, спиральное
Schlangenbohrer
Vrták hadovitý



Nr. ref.	Dane techniczne	Kod EAN
CON-DA230-6	6,0 x 230 mm	5902143125174
CON-DA230-8	8,0 x 230 mm	5902143125181
CON-DA230-10	10,0 x 230 mm	5902143131809
CON-DA230-12	12,0 x 230 mm	5902143131816
CON-DA230-14	14,0 x 230 mm	5902143131823
CON-DA230-16	16,0 x 230 mm	5902143122067
CON-DA230-18	18,0 x 230 mm	5902143122074
CON-DA230-20	20,0 x 230 mm	5902143122081
CON-DA230-22	22,0 x 230 mm	5902143122098
CON-DA230-24	24,0 x 230 mm	5902143122104
CON-DA230-26	26,0 x 230 mm	5902143122111
CON-DA230-28	28,0 x 230 mm	5902143122128
CON-DA230-30	30,0 x 230 mm	5902143122135
CON-DA230-32	32,0 x 230 mm	5902143122142
CON-DA230-34	34,0 x 230 mm	5902143122159
CON-DA230-36	36,0 x 230 mm	5902143122166
CON-DA460-6	6,0 x 460 mm	5902143125198
CON-DA460-8	8,0 x 460 mm	5902143125204
CON-DA460-10	10,0 x 460 mm	5902143122173
CON-DA460-12	12,0 x 460 mm	5902143122180
CON-DA460-14	14,0 x 460 mm	5902143131830

CON-DA460-16	16,0 x 460 mm	5902143131847
CON-DA460-18	18,0 x 460 mm	5902143131854
CON-DA460-20	20,0 x 460 mm	5902143131861
CON-DA460-22	22,0 x 460 mm	5902143131878
CON-DA460-24	24,0 x 460 mm	5902143131885
CON-DA460-26	26,0 x 460 mm	5902143131892
CON-DA460-28	28,0 x 460 mm	5902143131908
CON-DA460-30	30,0 x 460 mm	5902143131915
CON-DA460-32	32,0 x 460 mm	5902143131922
CON-DA460-34	34,0 x 460 mm	5902143131939
CON-DA460-36	36,0 x 460 mm	5902143131946
CON-DA600-10	10,0 x 600 mm	5902143127031
CON-DA600-12	12,0 x 600 mm	5902143127048
CON-DA600-14	14,0 x 600 mm	5902143127055
CON-DA600-16	16,0 x 600 mm	5902143127062
CON-DA600-18	18,0 x 600 mm	5902143127079
CON-DA600-20	20,0 x 600 mm	5902143127086
CON-DA600-22	22,0 x 600 mm	5902143127093
CON-DA600-24	24,0 x 600 mm	5902143127109
CON-DA600-26	26,0 x 600 mm	5902143127116
CON-DA600-28	28,0 x 600 mm	5902143127123
CON-DA600-30	30,0 x 600 mm	5902143127130
CON-DA600-32	32,0 x 600 mm	5902143127147
CON-DA600-34	34,0 x 600 mm	5902143127154
CON-DA600-36	36,0 x 600 mm	5902143127161

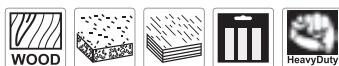

CON-DŁ-28	28,0 mm	5902143113980
CON-DŁ-30	30,0 mm	5902143113997
CON-DŁ-32	32,0 mm	5902143114000
CON-DŁ-34	34,0 mm	5902143114017
CON-DŁ-36	36,0 mm	5902143114024
CON-DŁ-38	38,0 mm	5902143128489

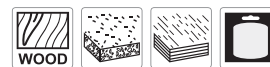

Wiertła do drewna kręte

Auger drill bits for wood
Свёрла по дереву, спиральные
Schlangenbohrer
Vrtáky hadovité



Nr. ref.	Dane techniczne	Kod EAN
CON-DA-601	6,0-20,0 mm x 230 mm; 6 szt.	5902143119432
CON-DA-801	8,0-22,0 mm x 460 mm; 8 szt.	5902143119449

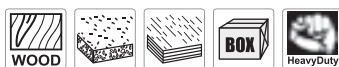

Wiertło do drewna łopatkowe

Spade wood drill bit
Свёрло перовое по дереву
Holz-Flachfräsbohrer
Vrták do dreva, plochéy

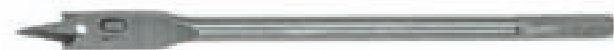

Nr. ref.	Dane techniczne	Kod EAN
CON-DŁ-10	10,0 mm	5902143113898
CON-DŁ-12	12,0 mm	5902143113904
CON-DŁ-14	14,0 mm	5902143113911
CON-DŁ-16	16,0 mm	5902143113928
CON-DŁ-18	18,0 mm	5902143113935
CON-DŁ-20	20,0 mm	5902143113942
CON-DŁ-22	22,0 mm	5902143113959
CON-DŁ-24	24,0 mm	5902143113966
CON-DŁ-26	26,0 mm	5902143113973

Wiertła do drewna łopatkowe

Spade wood drill bits
Свёрла перовые по дереву
Holz-Flachfräsbohrer
Vrtáky do dreva, ploché



Nr. ref.	Dane techniczne	Kod EAN
CON-DŁ-Z6	10,0-25,0 mm; 6 szt.	5902143110934

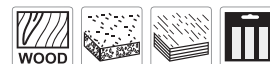

Wiertła do drewna szlifowane

Wood drill bits, ground
Свёрла по дереву, шлифованное
Holzbohrer, geschliffen
Vrtáky do dreva, brúsené



Nr. ref.	Dane techniczne	Kod EAN
CON-1150	4,0-10,0 mm; 5 szt.	5902143113775
CON-1158	3,0-10,0 mm; 8 szt.	5902143113782



Wiertło do szkła

Glass drill bit
Сверло по стеклу
Glasbohrer
Vrták do skla



Nr. ref.	Dane techniczne	Kod EAN
CON-GD-3	3,0 mm	5902143118336
CON-GD-4	4,0 mm	5902143118343
CON-GD-5	5,0 mm	5902143118350
CON-GD-6	6,0 mm	5902143118367
CON-GD-8	8,0 mm	5902143118381
CON-GD-10	10,0 mm	5902143118404



Wiertła - metal/drewno/cegła

Drills for: metal/wood/brick
Свёрла по металлу/дереву/кирпичу
Bohrer: Metall/Holz/Ziegel
Vrtáky: kov/drevo/tehla



Nr. ref.	Dane techniczne	Kod EAN
CON-1133	5/6/8 mm x 3; 9 szt.	5902143138624
CON-1134	3/4/5/6/8/10 mm x 3; 18 szt.	5902143137139



Wiertło uniwersalne tytanowane

Multi-purpose drill bit
Сверло универсальное
Universalbohrer
Vrták univerzálný



Nr. ref.	Dane techniczne	Kod EAN
CON-UD-4	4,0 mm	5902143138419
CON-UD-5	5,0 mm	5902143138426
CON-UD-6	6,0 mm	5902143138433
CON-UD-7	7,0 mm	5902143129349
CON-UD-8	8,0 mm	5902143129356
CON-UD-10	10,0 mm	5902143129363
CON-UD-12	12,0 mm	5902143129370
CON-UD-14	14,0 mm	5902143129387
CON-UD-16	16,0 mm	5902143129394
CON-UD-18	18,0 mm	5902143129400
CON-UD-20	20,0 mm	5902143129417
CON-UD-22	22,0 mm	5902143129424
CON-UD-25	25,0 mm	5902143129431



Wiertła - metal/drewno/beton

Drills for - metal/wood/concrete
Свёрла по - металлу/дереву/бетону
Bohrer - Metall/Holz/Beton
Vrtáky - kov/drevo/betón



Nr. ref.	Dane techniczne	Kod EAN
CON-1400	4,0-10,0 mm; 300 szt.	5902143111894



Wiertła uniwersalne tytanowane

Multi-purpose drill bits
Свёрла универсальные
Universalbohrer
Vrtáky univerzálné



Nr. ref.	Dane techniczne	Kod EAN
CON-UD-Z5	4,0-10,0 mm; 5 szt.	5902143129448



Frez puszkowy

Forstner bit
Сверло Форстнера
Forstnerbohrer
Forstnerovy vrták



Nr. ref.	Dane techniczne	Kod EAN
XDC-26	26 mm	5902143106449
XDC-35	35 mm	5902143106456

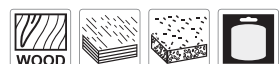

Frez puszkowy z widią

Forstner bit
Сверло Фоснера
Forstnerbohrer
Forstnerovy vrták



Nr. ref.	Dane techniczne	Kod EAN
XDC-26T	26 mm	5902143122463
XDC-35T	35 mm	5902143112136

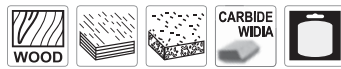

Frezy stolarskie szybkotnące

Router bits
Фрезы по дереву, профильные
Profile fräsen
Frézy stolárske



Nr. ref.	Dane techniczne	Kod EAN
CON-FR6	6 szt.	5902143110743



Frezy puszkowe

Forstner bits
Сверла Фоснера
Forstnerbohrers
Forstnerove vrtáky



Nr. ref.	Dane techniczne	Kod EAN
CON-XDC-Z5	15,0-35,0 mm; 5 szt.	5902143110903

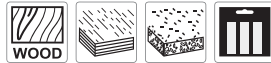

Frezy stolarskie szybkotnące

Router bits
Фрезы по дереву, профильные
Profile fräsen
Frézy stolárske



Nr. ref.	Dane techniczne	Kod EAN
CON-FR12	12 szt.	5902143107224



Flekownik-sękownik

Plug cutter
Сверло пробочные
Versenkbohrer
Sukovník



Nr. ref.	Dane techniczne	Kod EAN
CON-XDS-15	15 mm; 2 szt.	5902143104094
CON-XDS-20	20 mm; 2 szt.	5902143104100
CON-XDS-25	25 mm; 2 szt.	5902143104117
CON-XDS-30	30 mm; 2 szt.	5902143104124
CON-XDS-35	35 mm; 2 szt.	5902143105497



Flekownik-sękownik

Plug cutter
Сверло пробочные
Versenkbohrer
Sukovník



Nr. ref.	Dane techniczne	Kod EAN
CON-XDS-Z5	15/20/25/30/35 mm; 5 x 2 szt.	5902143104131



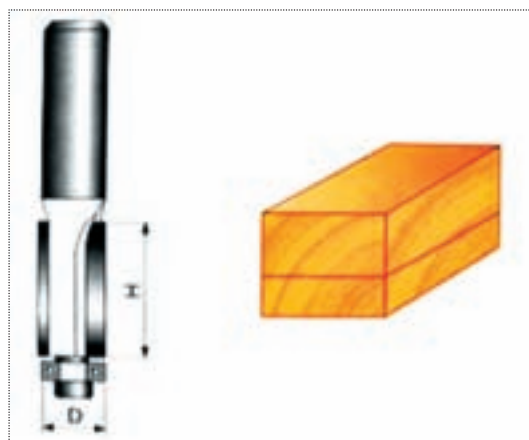
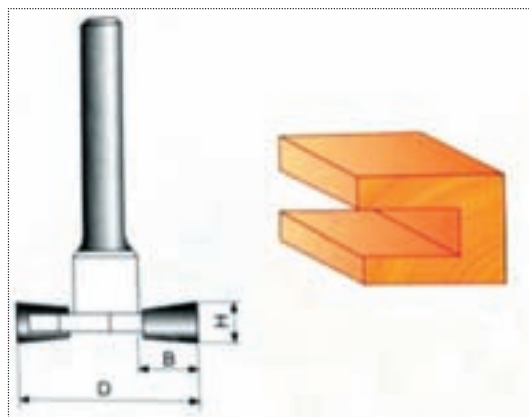
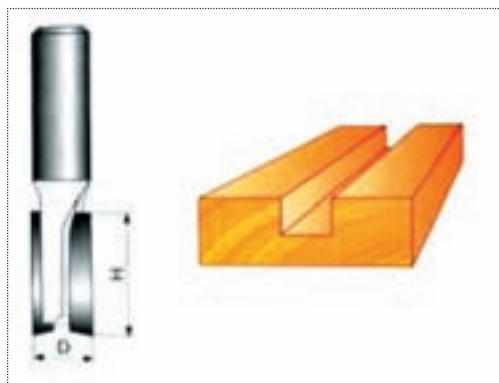

Frez stolarski szybkotnący

Router bit
Фреза по дереву, профильная
Profile fräser
Fréza stolárska



Nr. ref.	Dane techniczne (Z)x(D)x(H)	Kod EAN
CON-RB-201	8 x 2 x 6 x 19 mm	5902143124931
CON-RB-202	8 x 2 x 8 x 19 mm	5902143124948
CON-RB-203	8 x 2 x 10 x 25 mm	5902143124955
CON-RB-204	8 x 2 x 12 x 25 mm	5902143124962
CON-RB-205	8 x 2 x 14 x 19 mm	5902143124979



CON-RB-805	8 x 32 x 8 x 9,4 mm	5902143124986
CON-RB-806	8 x 32 x x 10 x 9,4 mm	5902143124993
CON-RB-807	8 x 32 x 12 x 9,4 mm	5902143125006



Nr. ref.	Dane techniczne (D)x(H)	Kod EAN
CON-RB-102	8 x 8 x 19 mm	5902143125013
CON-RB-103	8 x 10 x 25 mm	5902143125020
CON-RB-104	8 x 12 x 25 mm	5902143125037



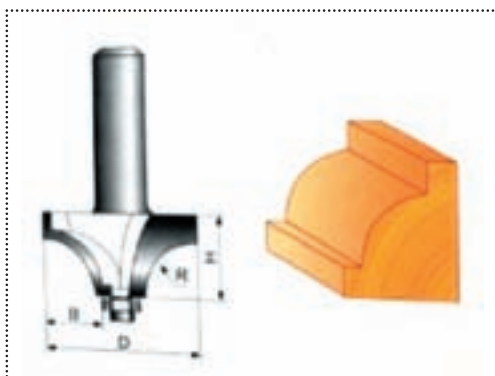
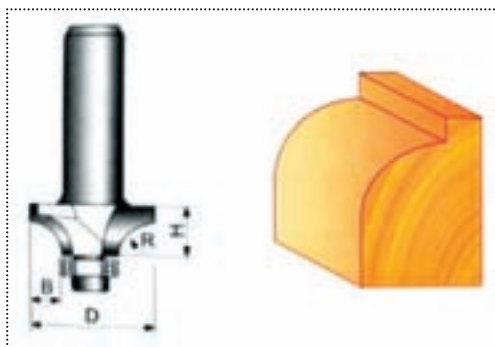
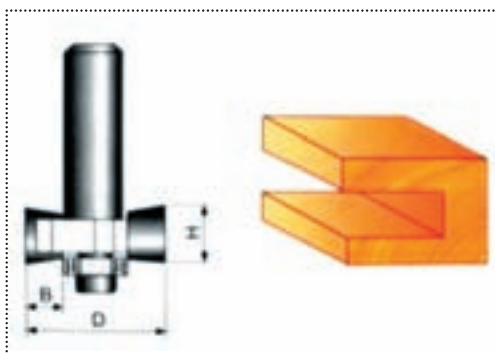

Frez stolarski szybkotnący

Router bit
Фреза по дереву, профильная
Profile fräser
Fréza stolárska



Nr. ref.	Dane techniczne (D)x(B)x(H)	Kod EAN
CON-RB-305	8 x 32 x 9,4 x 8 mm	5902143125044
CON-RB-306	8 x 32 x 9,4 x 10 mm	5902143125051
CON-RB-307	8 x 32 x 9,4 x 12 mm	5902143125068



Nr. ref.	Dane techniczne (D)x(R)x(B)x(H)	Kod EAN
CON-RB-706	8 x 32 x 9,52 x 16 mm	5902143125075
CON-RB-707	8 x 35 x 11,1 x 11,1 x 16 mm	5902143125082
CON-RB-708	8 x 38,1 x 12,7 x 12,7 x 19 mm	5902143125099



CON-RB-905	8 x 28,6 x 7,96 x 9,8 x 12,5 mm	5902143125105
CON-RB-906	8 x 32 x 9,52 x 11,3 x 15,5 mm	5902143125112
CON-RB-907	8 x 35 x 15,1 x 11,1 x 12,9 mm	5902143125129



Frezowiertła

Milling cutters
Свёрла-фрезы
Fräsbohrer
Frézové vrtáky



Nr. ref. **Dane techniczne** **Kod EAN**
CON-MSD-Z5 3,0-8,0 mm; 5 szt. 5902143118428



Uchwyt wiertarski zębaty z kluczykiem

Keyed drill
Патрон с зубчатым венцом в комплекте с ключом
Zahnkranzbohrfutter
Skľučovadlo s ozubeným vencom



Nr. ref. **Dane techniczne** **Kod EAN**
CON-DC-3513 1/2"-20UNF; od 1,5-13,0 mm 5902143133308



Uchwyt szybkozasciskowy do wkrętarci

Keyless drill chuck
Патрон быстрозажимной
Schnellspannfutter
Skľučovadlo rýchloúpinacie



Nr. ref. **Dane techniczne** **Kod EAN**
CON-DC-1510 3/8"-24UNF; od 0,8-10,0 mm 5902143133322



Uchwyt wiertarski szybkozasciskowy

Keyless drill chuck
Патрон быстрозажимной
Schnellspannfutter
Skľučovadlo rýchloúpinacie



Nr. ref. **Dane techniczne** **Kod EAN**
CON-DC-99C 1/2"-20UNF; od 2,0-13,0 mm 5902143130994



Uchwyt wiertarski szybkozasciskowy

Keyless drill chuck
Патрон быстрозажимной
Schnellspannfutter
Skľučovadlo rýchloúpinacie



Nr. ref. **Dane techniczne** **Kod EAN**
CON-DC-1513 1/2"-20UNF; od 2,0-13,0 mm 5902143133315



Uchwyt wiertarski szybkozasciskowy

Keyless drill chuck
Патрон быстрозажимной
Schnellspannfutter
Skľučovadlo rýchloúpinacie



Nr. ref. **Dane techniczne** **Kod EAN**
CON-DC-99VA 1/2"-20UNF; od 2,0-13,0 mm 5902143130987



Kluczyk uniwersalny do wiertarki

Multi purpose chuck key
Ключ для патрона дрели
Universal Bohrfutterschlüssel
Kľúč na skľučovadlo vŕtačky



Nr. ref.

Kod EAN

CON-5674

5902143118626



Otwornice wolframowe

Tungsten hole saws
Коронки вольфрамовые
Wolfram-Stichsägen
Dierovačky volfrámové



Nr. ref.

Dane techniczne

Kod EAN

CON-HSW-Z06 33-73 mm - 6 szt.

5902143133759

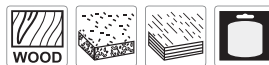

Wycinak otworów do glazury

Tile hole cutter
Кругорез по керамике
Fliesenlochmesser
Výsečník otvorov do glazúry

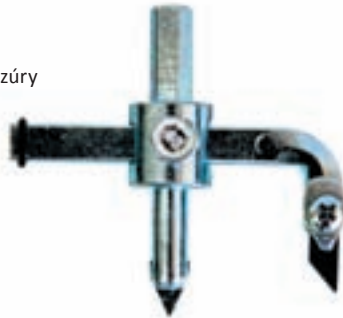

Nr. ref.

Dane techniczne

Kod EAN

CON-PC-002 30-110 mm

5902143100607



Ostrze widiowe zapasowe

Carbide-tipped blade
Лезвие из твёрдого сплава
Widiaschneide
Vidiové ostrie



Nr. ref.

Dane techniczne

Kod EAN

CON-PC-02CT do CON-PC-002

5902143140054



Wycinak do otworów z regulacją

Adjustable hole cutter
Регулируемый резец отверстия
Lochsneider einstellbar
Vyrezávač otvorov nastaviteľný



Nr. ref.

Dane techniczne

Kod EAN

CON-HSG-01 64 mm

5902143137375



Otwornice do drewna

Wood cutting hole saws
Коронки по дереву
Holzstichsägen
Dierovačky do dreva



Nr. ref.

Dane techniczne

Kod EAN

CON-HSW-01 26-63 mm, h 25 mm - 7 szt.

5902143133018

CON-HSW-02 26-63 mm, h 50 mm - 7 szt.

5902143133025

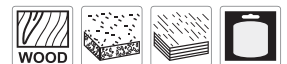

Otwornice do drewna zęby hartowane

Wood cutting hole saws, hardened teeth
Коронки по дереву, зубья закалённые
Holzstichsägen, Zähne gehärtet
Dierovačky do dreva, kalené zuby



Nr. ref.

Dane techniczne

Kod EAN

CON-HSW-03 26-63 mm, h 25 mm - 7 szt.

5902143133032

CON-HSW-04 26-63 mm, h 50 mm - 7 szt.

5902143133049

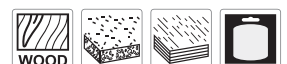

Otwornice do drewna

Wood cutting hole saws
Коронки по дереву
Holzstichsägen
Dierovačky do dreva



Nr. ref. **Dane techniczne** **Kod EAN**
CON-1805 60/67/74/81/95 mm, H=30mm - 7 szt. 5902143134107

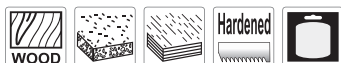

Otwornice do drewna z adapterem

Wood cutting hole saws with adaptor
Коронки по дереву с державкой
Holzstichsägen mit Adapter
Dierovačky do dreva s adaptérom



Nr. ref. **Dane techniczne** **Kod EAN**
CON-1808 51-102 mm; 9 szt. 5902143110989



Otwornice do drewna z adapterem

Wood cutting hole saws with adaptor
Коронки по дереву с державкой
Holzstichsägen mit Adapter
Dierovačky do dreva s adaptérom



Nr. ref. **Dane techniczne** **Kod EAN**
CON-1806 19-63 mm; 11 szt. 5902143110972



Wycinak otworów uniwersalny

Multi-purpose hole cutter
Кругорез универсальный
Lochmesser universal
Výsečník otvorov univerzálny



Nr. ref. **Dane techniczne** **Kod EAN**
CON-PC-003 30-150 mm 5902143101109

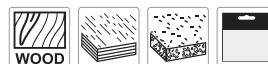

Wycinak otworów do drewna

Cross-cut chisel
Кругорез по дереву
Holzlochmesser
Výsečník otvorov do dreva



Nr. ref. **Dane techniczne** **Kod EAN**
CON-1807 30-120 mm 5902143112976



Ostrzałka do wiertel z zapasowym kamieniem

Drill bit sharpener with spare grindstone
Точилка для свёрл с запасным точильным камнем
Bohrerschleifstein mit Ersatzstein
Ostrička vrtákov so zásobným kameňom



Nr. ref. **Dane techniczne** **Kod EAN**
CON-0620 3,6-10,0 mm 5902143117612



Końcówki krzyżowe

Bits for cross head screws
 Биты крестовые
 Kreuzschlitz bits
 Bity krížové



Nr. ref.	Dane techniczne	Kod EAN
C-C3002-0	PH 0 x 25 mm; 3 szt.	5902143109815
C-C3002-1	PH 1 x 25 mm; 3 szt.	5902143109822
C-C3002-1-30	PH 1 x 25 mm; 30 szt.	5902143119173
C-C3002-2	PH 2 x 25 mm; 3 szt.	5902143109761
C-C3002-2-30	PH 2 x 25 mm; 30 szt.	5902143119180
C-C3002-3	PH 3 x 25 mm; 3 szt.	5902143109839
C-C4002-1	PH 1 x 50 mm; 3 szt.	5902143109853
C-C4002-2	PH 2 x 50 mm; 3 szt.	5902143109860
C-C4002-3	PH 3 x 50 mm; 3 szt.	5902143109877

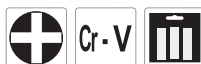

Końcówki płaskie

Bits for slotted head screws
 Биты шлицевые
 Flachs Schlitz bits
 Bity ploché



Nr. ref.	Dane techniczne	Kod EAN
C-C3001-4	SL 4,0 x 0,6 x 25 mm; 3 szt.	5902143109778
C-C3001-5	SL 5,0 x 0,8 x 25 mm; 3 szt.	5902143109785
C-C3001-6	SL 6,0 x 1,0 x 25 mm; 3 szt.	5902143109792
C-C3001-8	SL 8,0 x 1,2 x 25 mm; 3 szt.	5902143109808

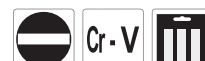

Końcówki krzyżowe

Bits for cross head screws
 Биты крестовые
 Kreuzschlitz bits
 Bity krížové



Nr. ref.	Dane techniczne	Kod EAN
C-C3003-1	PZ 1 x 25 mm; 3 szt.	5902143109914
C-C3003-1-30	PZ 1 x 25 mm; 30 szt.	5902143119197
C-C3003-2	PZ 2 x 25 mm; 3 szt.	5902143109921
C-C3003-2-30	PZ 2 x 25 mm; 30 szt.	5902143119203
C-C3003-3	PZ 3 x 25 mm; 3 szt.	5902143109938
C-C4003-1	PZ 1 x 50 mm; 3 szt.	5902143109952
C-C4003-2	PZ 2 x 50 mm; 3 szt.	5902143109969
C-C4003-3	PZ 3 x 50 mm; 3 szt.	5902143109976

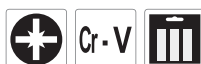

Końcówki Torx

Bits for Torx® head screws
 Биты Torx
 Torx-Bits
 Bity Torx



Nr. ref.	Dane techniczne	Kod EAN
C-C3006-8	T 8 x 25 mm; 3 szt.	5902143110224
C-C3006-9	T 9 x 25 mm; 3 szt.	5902143110231
C-C3006-10	T 10 x 25 mm; 3 szt.	5902143110019
C-C3006-15	T 15 x 25 mm; 3 szt.	5902143110026
C-C3006-20	T 20 x 25 mm; 3 szt.	5902143110033
C-C3006-25	T 25 x 25 mm; 3 szt.	5902143110040
C-C3006-27	T 27 x 25 mm; 3 szt.	5902143110057
C-C3006-30	T 30 x 25 mm; 3 szt.	5902143110064
C-C3006-40	T 40 x 25 mm; 3 szt.	5902143110071

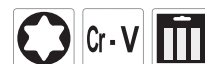

Końcówki krzyżowe z ogranicznikiem

Bits for cross head screws with limiter
 Биты крестовые с ограничителем
 Kreuzschlitz bits mit Begrenzer
 Bity krížové s obmedzovačom



Nr. ref.	Dane techniczne	Kod EAN
C-C3002LF-1	PH 1 x 25 mm; 2 szt.	5902143125211
C-C3002LF-2	PH 2 x 25 mm; 2 szt.	5902143125228
C-C3002LF-2-1	PH 2 x 25 mm; 1 szt.	5902143132516
C-C3003LF-1	PZ 1 x 25 mm; 2 szt.	5902143125235
C-C3003LF-2	PZ 2 x 25 mm; 2 szt.	5902143125242



Końcówki sześciokątne

Hex bits
 Биты Hex
 Hex-Bits
 Bity Hex



Nr. ref.	Dane techniczne	Kod EAN
C-C3004-3	H 3 x 25 mm; 3 szt.	5902143110156
C-C3004-4	H 4 x 25 mm; 3 szt.	5902143110163
C-C3004-5	H 5 x 25 mm; 3 szt.	5902143110170
C-C3004-6	H 6 x 25 mm; 3 szt.	5902143110187
C-C3004-8	H 8 x 25 mm; 3 szt.	5902143110194

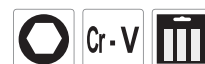

Nasadka z magnesem typ „Farmer”

Magnetic socket, „Farmer” type
 Насадка с магнитом, тип „Farmer”
 Magnet Aufsatz, Typ „Farmer”
 Magnetická stopková hlavica „Farmer”



Nr. ref.	Dane techniczne	Kod EAN
CON-NM7-1	7 mm	5902143131441
CON-NM8-1	8 mm	5902143121466
CON-NM10-1	10 mm	5902143121473
CON-NM13-1	13 mm	5902143121480

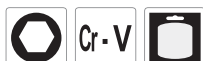

Nasadki do wkrętarek

Sockets
 Насадки
 Aufsatz
 Stopková hlavica



Nr. ref.	Dane techniczne	Kod EAN
CON-5213	5/6/7/8/9/10/11/12 mm; 8 szt.	5902143134077

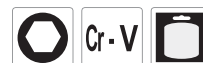

Nasadki z magnesem typ „Farmer”

Magnetic sockets, „Farmer” type
 Насадки с магнитом, тип „Farmer”
 Magnet Aufsetzen, Typ „Farmer”
 Magnetické stopkové hlavice „Farmer”



Nr. ref.	Dane techniczne	Kod EAN
CON-NM8	8 mm; 5 szt.	5902143107026
CON-NM10	10 mm; 5 szt.	5902143107033
CON-NM13	13 mm; 5 szt.	5902143107019

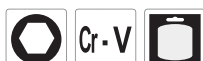

Uchwyt magnetyczny do końcówek

Magnetic bit holder
 Держатель магнитный
 Magnethalter
 Magnetický úchyt do koncoviek 1/4”

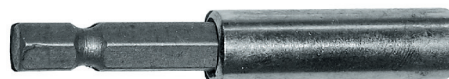

Nr. ref.	Dane techniczne	Kod EAN
CON-U316-1	1/4”, 60 mm	5902143127956

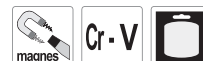

Końcówki z uchwytem magnetycznym

Bits with magnetic holder
 Биты с магнитным держателем
 Schrauberbits mit Magnethalter
 Bity s magnetickým úchytom



Nr. ref.	Dane techniczne	Kod EAN
CON-5294	SL4/6/8; PH1/2/3; PZ1/2/3 - 50 mm; 10 szt.	5902143125396
CON-5207	SL 4/5, PH 1/2, PZ 1/2; 7 szt.	5902143134060



Nasadki magnetyczne do końcówek

Magnetic sockets for bits
 Насадки с магнитом для бит
 Bithalter
 Magnetické držiaki bitov



Nr. ref.	Dane techniczne	Kod EAN
CON-U316	1/4”, 60 mm; 5 szt.	5902143107040

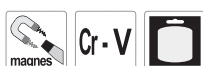

Końcówki dwustronne

Double sided bits
 Биты двухсторонние
 Schrauberbits doppelseitig
 Bity dvojstranné



Nr. ref. **Dane techniczne** **Kod EAN**
 CON-5209 SL/PH/PZ/ x 65 mm; 10 szt. 5902143113799



Końcówki

Bits
 Биты
 Schrauberbits
 Bity



Nr. ref. **Dane techniczne** **Kod EAN**
 CON-5210 PH/PZ/Hx/Tx/Ns x 25 mm; 30 szt. 5902143113331



Końcówki z uchwytem magnetycznym

Bits with magnetic holder
 Биты с магнитным держателем
 Schrauberbits mit Magnethalter
 Bity s magnetickým úchytom



Nr. ref. **Dane techniczne** **Kod EAN**
 CON-5211 25 mm; 33 szt. 5902143113317



Końcówki z uchwytem magnetycznym

Bits with magnetic holder
 Биты с магнитным держателем
 Schrauberbits mit Magnethalter
 Bity s magnetickým úchytom



Nr. ref. **Dane techniczne** **Kod EAN**
 CON-5212 25 mm; 100 szt. 5902143113324



Końcówki

Bits
 Биты
 Schrauberbits
 Bity



Nr. ref. **Dane techniczne** **Kod EAN**
 CON-5290 SL 3/5/7; PH 1/2/3; H 3/4/5/6 x 25 mm; 10 szt. 5902143111856



Końcówki z uchwytem magnetycznym

Bits with magnetic holder
 Биты с магнитным держателем
 Schrauberbits mit Magnethalter
 Bity s magnetickým úchytom



Nr. ref. **Dane techniczne** **Kod EAN**
 CON-5292 SL6; PH1/2; PH1/2; PH2; PZ1/2/3 - 50/65/100/110 mm; 10 szt. 5902143111863



Końcówki

Bits
Биты
Schrauberbits
Bity



Nr. ref. **Dane techniczne** **Kod EAN**
CON-5296 SL3/5/7; PH1/2/3; PZ1/2/3 x 150 mm; 10 szt. 5902143110750



Magnetyzer - demagnetyzer

Magnetizer - demagnetizer
Устройство для намагничивания и размагничивания
Magnetisierer - Entmagnetisierer
Magnetizér - demagnetizér



Nr. ref. **Kod EAN**
CON-WKM-01 5902143130444



Wiertła i bity

Drills and bits
Сверла и биты
Bohren und Schrauben Bits
Vrtáky a bity



Nr. ref. **Dane techniczne** **Kod EAN**
CON-SB-Z118 118 szt. 5902143132578



Wiertła i bity

Drills and bits
Сверла и биты
Bohren und Schrauben Bits
Vrtáky a bity



Nr. ref. **Dane techniczne** **Kod EAN**
CON-SB-Z122 122 szt. 5902143132530



Wiertła i bity

Drills and bits
Сверла и биты
Bohren und Schrauben Bits
Vrtáky a bity



Nr. ref. **Dane techniczne** **Kod EAN**
CON-SB-Z215 215 szt. 5902143132547



Wiertła i bity

Drills and bits
Сверла и биты
Bohren und Schrauben Bits
Vrtáky a bity



Nr. ref. **Dane techniczne** **Kod EAN**
CON-SB-Z57 57 szt. 5902143132523



Tarcza diamentowa do cięcia na mokro pełna

Diamond cutting blade, wet cutting, full
Круг отрезной алмазный сплошной, для мокрой резки
Segment-Diamantblatt zum Nassschneiden, voll
Diamantový rezný segmentový kotúč, mokré rezanie



Nr. ref.	Dane techniczne	Kod EAN
CODB-W115	115 mm	5902143107132
CODB-W125	125 mm	5902143107149
CODB-W180	180 mm	5902143125167
CODB-W180-25	180 x 25,4 mm	5902143133346
CODB-W230	230 mm	5902143107156



Tarcza diamentowa do cięcia na sucho TURBO

Diamond cutting blade, dry cutting, TURBO
Круг отрезной алмазный, для сухой резки TURBO
Segment-Diamantblatt zum Trockenschneiden TURBO
Diamantový rezný segmentový kotúč TURBO, suché rezanie



Nr. ref.	Dane techniczne	Kod EAN
CODB-T115	115 mm	5902143107767
CODB-T125	125 mm	5902143107774
CODB-T230	230 mm	5902143115267



Tarcza diamentowa do cięcia na sucho segmentowa

Diamond cutting blade, dry cutting, segmented
Круг отрезной алмазный, сегментный, для сухой резки
Segment-Diamantblatt zum Trockenschneiden
Diamantový rezný segmentový kotúč, suché rezanie



Nr. ref.	Dane techniczne	Kod EAN
CODB-D115	115 mm	5902143107163
CODB-D125	125 mm	5902143107170
CODB-D180	180 mm	5902143125150
CODB-D180-25,4	180 x 25,4 mm	5902143133339
CODB-D230	230 mm	5902143107187



Piła tarczowa do drewna

Circular wood cutting saw
Пила дисковая по дереву
Holz-kreissäge
Pila kotúčová do dreva



Nr. ref.	Dane techniczne	Kod EAN
CON-TCT-13x16	130 mm x 16 T	5902143114031
CON-TCT-13x24	130 mm x 24 T	5902143114048
CON-TCT-14x24	140 mm x 24 T	5902143114055
CON-TCT-15x30	150 mm x 30 T	5902143114062
CON-TCT-16x24	160 mm x 24 T	5902143114079
CON-TCT-16x36	160 mm x 36 T	5902143114086
CON-TCT-17x36	170 mm x 36 T	5902143114093
CON-TCT-18x24	180 mm x 24 T	5902143114109
CON-TCT-18x40	180 mm x 40 T	5902143114116
CON-TCT-18x60	180 mm x 60 T	5902143114123
CON-TCT-19x40	190 mm x 40 T	5902143114130
CON-TCT-20x40	200 mm x 40 T	5902143114147
CON-TCT-20x60	200 mm x 60 T	5902143114154
CON-TCT-25x24	250 mm x 24 T	5902143114161
CON-TCT-25x40	250 mm x 40 T	5902143114178
CON-TCT-25x60	250 mm x 60 T	5902143114185
CON-TCT-30x40	300 mm x 40 T	5902143114192
CON-TCT-30x80	300 mm x 80 T	5902143114208
CON-TCT-30x100	300 mm x 100 T	5902143114215
CON-TCT-35x40	350 mm x 40 T	5902143114222

Nr. ref.	Dane techniczne	Kod EAN
CON-TCT-35x60	350 mm x 60 T	5902143114239
CON-TCT-35x80	350 mm x 80 T	5902143114246
CON-TCT-35x100	350 mm x 100 T	5902143114253
CON-TCT-40x40	400 mm x 40 T	5902143114260
CON-TCT-40x60	400 mm x 60 T	5902143114277
CON-TCT-40x80	400 mm x 80 T	5902143114284
CON-TCT-40x100	400 mm x 100 T	5902143114291
CON-TCT-45x40	450 mm x 40 T	5902143131984
CON-TCT-45x100	450 mm x 100 T	5902143114307



Tarcza korundowa do cięcia metalu, odsadzona

Corundum cut-off wheel for metal, depressed
 Круг корундовый отрезной по металлу
 Trennscheibe für Metall
 Rezný kotúč na kovy



Tarcza korundowa do cięcia metalu, blachy

Corundum cut-off wheel for metal sheet, flat
 Круг корундовый отрезной по металлу / жести
 Trennscheibe für Metall/Blech
 Rezný kotúč na kovy



Nr. ref.	Dane techniczne	Kod EAN
CON-2M-115	115 x 3,0 mm	5902143100850
CON-2M-125	125 x 3,0 mm	5902143100867
CON-2M-230	230 x 3,0 mm	5902143100898



Nr. ref.	Dane techniczne	Kod EAN
CON-1KM-115	115 x 1,2 mm	5902143109495
CON-1KM-125	125 x 1,2 mm	5902143112129



Tarcza korundowa do cięcia betonu

Corundum cut-off wheel for concrete, flat
 Круг корундовый отрезной по бетону
 Trennscheibe für Beton
 Rezný kotúč na betón



Tarcza korundowa do cięcia metalu

Corundum cut-off wheel for metal, flat
 Круг корундовый отрезной по металлу
 Trennscheibe für Metall
 Rezný kotúč na kovy



Nr. ref.	Dane techniczne	Kod EAN
CON-1B-115	115 x 3,0 mm	5902143100904
CON-1B-125	125 x 3,0 mm	5902143100911
CON-1B-230	230 x 3,0 mm	5902143100942



Nr. ref.	Dane techniczne	Kod EAN
CON-1M-115	115 x 3,0 mm	5902143100805
CON-1M-125	125 x 3,0 mm	5902143100812
CON-1M-230	230 x 3,0 mm	5902143100843



Tarcza korundowa do cięcia betonu, odsadzona

Corundum cut-off wheel for concrete, depressed
Круг корундовый отрезной по бетону
Trennscheibe für Beton
Rezný kotúč na betón



Nr. ref.	Dane techniczne	Kod EAN
CON-2B-115	115 x 3,0 mm	5902143100959
CON-2B-125	125 x 3,0 mm	5902143100966
CON-2B-230	230 x 3,0 mm	5902143100997



Tarcza ścierna listkowa cyrkonowa

Flap disk, zirconium
Круг лепестковый, циркониевый
Lamellenscheibe, Zirkon
Kotúč brúsny lamelový, zirkonový



Nr. ref.	Dane techniczne	Kod EAN
CON-TSZ115-40	115 mm, P 40	5902143117377
CON-TSZ115-60	115 mm, P 60	5902143117384
CON-TSZ115-80	115 mm, P 80	5902143117391
CON-TSZ115-100	115 mm, P 100	5902143117407
CON-TSZ115-120	115 mm, P 120	5902143117414
CON-TSZ125-40	125 mm, P 40	5902143117421
CON-TSZ125-60	125 mm, P 60	5902143117438
CON-TSZ125-80	125 mm, P 80	5902143117445
CON-TSZ125-100	125 mm, P 100	5902143117452
CON-TSZ125-120	125 mm, P 120	5902143117469



Tarcza ścierna listkowa

Flap disk
Круг лепестковый
Lamellenscheibe
Kotúč brúsny lamelový



Nr. ref.	Dane techniczne	Kod EAN
CON-TS115-40	115 mm, P 40	5902143112204
CON-TS115-60	115 mm, P 60	5902143112211
CON-TS115-80	115 mm, P 80	5902143112228
CON-TS115-100	115 mm, P 100	5902143112235
CON-TS115-120	115 mm, P 120	5902143113522
CON-TS125-40	125 mm, P 40	5902143112259
CON-TS125-60	125 mm, P 60	5902143112266
CON-TS125-80	125 mm, P 80	5902143112273
CON-TS125-100	125 mm, P 100	5902143112280
CON-TS125-120	125 mm, P 120	5902143113539



Szczotka doczołowa

End brush
Щётка торцевая
Topfbürste
Hrnčeková kefa



Nr. ref.	Dane techniczne	Kod EAN
CON-SR-D50	50 mm	5902143118985
CON-SR-D70	70 mm	5902143118992
CON-SR-D100	100 mm	5902143119005



Szczotka doczołowa, drut skręcany

Knot wire End brush
Щётка торцевая
Topfbürste
Hrnčeková kefa



Nr. ref.	Dane techniczne	Kod EAN
CON-SR-DOS70	70 mm; M14	5902143119043
CON-SRR-DOS100	100 mm; M14	5902143122494



Szczotka tarczowa

Flat wire brush
Щётка дисковая
Scheibenbürste
Kefa okružní



Nr. ref.	Dane techniczne	Kod EAN
CON-SRR-TO100	100 mm; M14	5902143125501



Szczotka doczołowa, drut skręcany

Knot wire End brush
Щётка торцевая
Topfbürste
Hrnčeková kefa



Nr. ref.	Dane techniczne	Kod EAN
CON-SR-DTS75	75 mm	5902143119036



Szczotka tarczowa

Flat wire brush
Щётка дисковая
Scheibenbürste
Kefa okružní



Nr. ref.	Dane techniczne	Kod EAN
CON-SR-T80	80 mm	5902143119012
CON-SR-T100	100 mm	5902143119029



Szczotka tarczowa

Flat wire brush
Щётка дисковая
Scheibenbürste
Kefa okružní



Nr. ref.	Dane techniczne	Kod EAN
CON-SRR-O100	100 mm	5902143125518
CON-SRR-O125	125 mm	5902143125525
CON-SRR-O150	150 mm	5902143125532



Szczotka talerzowa skręcana

Knot wire flat brush
Щетка дисковая выгнутая
Scheibenbürste
Misková kefa



Nr. ref.	Dane techniczne	Kod EAN
CON-SRR-TLOS125	125 mm; M14	5902143125549



Szczotki stalowe tarczowe

Flat wire brushes
Щётки стальные дисковые
Stahlscheibenbürsten
Kefy oceľové kotúčové



Nr. ref.	Dane techniczne	Kod EAN
CON-SR-1830	25,0-75,0 mm; 5 szt.	5902143119074



Tarcza z włókniny ścierniej

Non-woven abrasive disk
Круг из нетканого абразивного материала
Schleifvliescheibe
Kotúč z brusnej tkaniny



Nr. ref.	Dane techniczne	Kod EAN
CON-RP-62	127 x 14 x 22,2 mm	5902143117919



Szczotki stalowe płasko-doczolowe

Flat-end wire brushes
Щётки стальные плоско-торцевые
Stahlflach-/Stirnbürsten
Kefy oceľové očkoploché



Nr. ref.	Dane techniczne	Kod EAN
CON-SR-1832	25,0-75,0 mm; 3 szt.	5902143119067



Ściernica trzpieniowa listkowa

Lamellar flap wheel
Лепестковая шлифовальная головка
Fächerschleifer aus Schleifvlies
Lamelový kotúč so stopkou



Nr. ref.	Dane techniczne	Kod EAN
CON-RPA-01	30 x 10 x 6 mm, P 40	5902143140597
CON-RPA-02	30 x 15 x 6 mm, P 40	5902143140603
CON-RPA-03	40 x 15 x 6 mm, P 40	5902143140610
CON-RPA-04	50 x 20 x 6 mm, P 40	5902143140627
CON-RPA-05	50 x 30 x 6 mm, P 40	5902143140634
CON-RPA-06	60 x 15 x 6 mm, P 40	5902143140641
CON-RPA-07	60 x 30 x 6 mm, P 40	5902143140658
CON-RPA-08	80 x 30 x 6 mm, P 40	5902143140665
CON-RPA-09	80 x 40 x 6 mm, P 40	5902143140672



Ściernica trzpieniowa z włókniny ścierniej

Non-woven flap wheel
Шлифовальная головка из абразивного нетканого материала
Schaftschleifscheibe aus Schleifvlies
Brúsný kotúč čapový z brusnej tkaniny



Nr. ref.	Dane techniczne	Kod EAN
CON-RP-61	127 x 14 x 6 mm	5902143117902



Kamienie szlifierskie trzpieniowe

Grinding stones with shank
Камни шлифовальные
Schaftschleifsteine
Brúsné kamene



Nr. ref.	Dane techniczne	Kod EAN
CON-1820	Kamienie szlifierskie trzpieniowe; 5 szt.	5902143134114



Ściernica trzpieniowa listkowa

Lamellar flap wheel

Шлифовальная головка из абразивной ткани

Fächerschleifer aus Schleifvlies

Brúsný kotúč čapový listový



Nr. ref.	Dane techniczne	Kod EAN
CON-RP-64	32 x 6 mm	5902143117650
CON-RP-65	63,5 x 6 mm	5902143117667



Rotopuc na rzep z futerkiem polerskim

Backing pad, Velcro, polishing lambswool

Тарелка опорная, полировальная на липучке; натуральная овчина

Klett-Stützteller, Lamwoll

Násadka pre brúsenie



Nr. ref.	Dane techniczne	Kod EAN
CON-RP10	125 mm	5902143100010



Tarniki trzpieniowe

Wood rasps with shank

Шарошки абразивные

Schaftraspeln

Profilové rašple



Nr. ref.	Dane techniczne	Kod EAN
CON-1825	5 szt.	5902143134121



Rotopuc na rzep

Backing pad, Velcro

Тарелка опорная, полировальная на липучке

Klett-Stützteller

Násadka pre brúsenie, na suchý zip



Nr. ref.	Dane techniczne	Kod EAN
CON-RP11	125 mm	5902143134046



Ściernica garnkowa

Cup-type grinding wheel

Круг шлифовальный чашечный конический

Kegeltopfschleifscheibe

Brúsný kotúč hrnkový kužeľový



Nr. ref.	Dane techniczne	Kod EAN
CON-BG-1112-NB	typ 1112 twardość NB; M14	5902143113188
CON-BG-1112-QB	typ 1112 twardość QB; M14	5902143113195



Multi-Flex z rzepem

Backing pad Multi-Flex, Velcro

Опорная тарелка на липучке

Stützteller mit Klett

Tanier unášací, suchý zip



Nr. ref.	Dane techniczne	Kod EAN
CON-RP11a	125 mm trzpień 8 mm	5902143142355



Rotoszlif na rzep

Foam backing pad, Velcro
Тарелка опорная, шлифовальная на липучке
Klett-Stützteller
Tanier unášací so suchým zipsom pre uhl. brúsky



Nr. ref.	Dane techniczne	Kod EAN
CON-RP16	125 mm; M14	5902143100249
CON-RP16/150	150 mm; M14	5902143102342



Trzpień do rotozslifu

Arbor for foam backing pad
Стержень для тарелки шлифовальной
Spanndorn für Klett-Stützteller
Adaptér na valcovú stopku



Nr. ref.	Dane techniczne	Kod EAN
CON-RP18	M14	5902143100263



Eurodysk z rzepem

Backing pad „Eurodisk”, Velcro
Опорная тарелка на липучке
Stützteller mit Klett
Tanier unášací, suchý zip



Nr. ref.	Dane techniczne	Kod EAN
CON-RP-19/150	150 mm, M14	5902143140795



Eurodysk z rzepem

Backing pad „Eurodisk”, Velcro
Тарелка опорная, шлифовальная на липучке
Klett-Stützteller
Tanier unášací so suchým zipsom



Nr. ref.	Dane techniczne	Kod EAN
CON-RP-19	125 mm, M14	5902143131526



Megadysk z rzepem

Spindle pad, Velcro
Опорная тарелка на липучке
Stützteller mit Klett
Tanier unášací, suchý zip



Nr. ref.	Dane techniczne	Kod EAN
CON-RP-27	125 mm; M14	5902143140993



Multidysk

Backing pad
Тарелка опорная, шлифовальная типа «Multidysk»
Stützteller «Multidysk»
Multidisk



Nr. ref.	Dane techniczne	Kod EAN
CON-RP28	125 mm	5902143100348



Tarcza do fibry

Backing pad
Тарелка опорная, шлифовальная
Stützteller für Fiberscheiben
Tanier unášací



Nr. ref.	Dane techniczne	Kod EAN
CON-RP-38	115 mm	5902143131533
CON-RP-39	125 mm	5902143131540
CON-RP-43	180 mm	5902143131557



Unidysk

Backing pad
Тарелка опорная, шлифовальная типа
Stützteller mit Schaft
Tanier unášací so skrutkou so stopkou



Nr. ref.	Dane techniczne	Kod EAN
CON-RP48	125 mm	5902143100430



Auto flesh

Auto flash sponge for paint polish
Тарелка полировальная типа «Auto flesh»
Polierschwamm
Leštiace penový kotúč



Nr. ref.	Dane techniczne	Kod EAN
CON-RP51	150 mm	5902143100454



Unidysk z rzepem

Backing pad, Velcro
Опорная тарелка на липучке
Stützteller mit Klett
Tanier unášací, suchý zip



Nr. ref.	Dane techniczne	Kod EAN
CON-RP48/150	150 mm	5902143140788



Futerko polerskie wiązane

Wool polishing pad, tied
Полировальник вязаный
Lammwoll Polierhaube
Kožušina leštiaca, viazaná



Nr. ref.	Dane techniczne	Kod EAN
CON-RP12	125 mm	5902143100034
CON-RP12/150	150 mm	5902143102359



Futerko polerskie na rzep

Wool polishing pad, Velcro
Полировальник на липучке
Lammwoll Polierhaube Mit Klett
Kožušina leštiaca, suchý zip



Nr. ref.	Dane techniczne	Kod EAN
CON-RP12a	125 mm	5902143100287



Unidysk

Backing pad
Тарелка опорная, шлифовальная типа
Stützteller mit Schaft
Tanier unášací so skrutkou so stopkou



Nr. ref.	Dane techniczne	Kod EAN
CON-RP49	125 mm	5902143100058



Rzep ochronny samoprzylepny

Self-adhesive Velcro
Липучка защитная, самоклеющаяся
Klett-Schleifscheibe, selbstklebend
Suchý zip ochranný samolepiaci



Nr. ref.	Dane techniczne	Kod EAN
CON-RP15	125 mm	5902143100232



Rzep wymienny; guma+klej

Replacement Velcro
Липучка сменная
Klett Schleifscheiben
Suchý zip vymeniteľný



Nr. ref.	Dane techniczne	Kod EAN
CON-RP17	125 mm	5902143100256



Gąbka polerska na rzep

Foam polishing pad, Velcro
Губка полировальная на липучке
Polierschwamm mit Klett
Hubka leštiaca, suchý zip



Nr. ref.	Dane techniczne	Kod EAN
CON-RP20	125 mm	5902143100270
CON-RP20/150	150 mm	5902143102298



Filc polerski na rzep

Polishing felt, Velcro
Войлочный полировочный кружок, на липучке
Polierfilz mit Klett
Plsť leštiaca, suchý zip



Nr. ref.	Dane techniczne	Kod EAN
CON-RP24	125 mm	5902143100324
CON-RP24/150	150 mm	5902143102366



Włóknina szlifierska na rzep

Grinding cloth, Velcro
Круг шлифовальный из нетканого абразивного волокна, на липучке
Schleifvlies mit Klett
Rúno brúsne na suchý zip



Nr. ref.	Dane techniczne	Kod EAN
CON-RP31	125 mm	5902143100355



Krażki ścierne na rzep

Sanding disks, Velcro
Круги шлифовальные на липучке
Klett Schleifscheiben
Brsné kotouče suchý zip



Nr. ref.	Dane techniczne	Kod EAN
CON-RP13z-24	125 mm, P 24; 5 szt.	5902143100157
CON-RP13z-36	125 mm, P 36; 5 szt.	5902143100164
CON-RP13z-40	125 mm, P 40; 5 szt.	5902143100171
CON-RP13z-60	125 mm, P 60; 5 szt.	5902143100188
CON-RP13z-80	125 mm, P 80; 5 szt.	5902143100195
CON-RP13z-100	125 mm, P 100; 5 szt.	5902143100201
CON-RP13z-120	125 mm, P 120; 5 szt.	5902143100218
CON-RP13z-150	125 mm, P 150; 5 szt.	5902143100225
CON-RP13z-220	125 mm, P 220; 5 szt.	5902143105480
CON-RP13z-36/25	125 mm, P 36; 25 szt.	5902143140900
CON-RP13z-60/25	125 mm, P 60; 25 szt.	5902143140917
CON-RP13z-80/25	125 mm, P 80; 25 szt.	5902143140924
CON-RP13z-100/25	125 mm, P 100; 25 szt.	5902143140931
CON-RP13z-120/25	125 mm, P 120; 25 szt.	5902143140948



Krażki ścierne na rzep

Sanding disks, Velcro
Круги шлифовальные на липучке
Klett Schleifscheiben
Brsné kotouče suchý zip



Nr. ref.	Dane techniczne	Kod EAN
CON-RPZ15-36	150 mm, P 36; 5 szt.	5902143140801
CON-RPZ15-60	150 mm, P 60; 5 szt.	5902143140818
CON-RPZ15-80	150 mm, P 80; 5 szt.	5902143140825
CON-RPZ15-100	150 mm, P 100; 5 szt.	5902143140832
CON-RPZ15-120	150 mm, P 120; 5 szt.	5902143140849
CON-RPZ15-36/25	150 mm, P 36; 25 szt.	5902143140955
CON-RPZ15-60/25	150 mm, P 60; 25 szt.	5902143140962
CON-RPZ15-80/25	150 mm, P 80; 25 szt.	5902143140979
CON-RPZ15-100/25	150 mm, P 100; 25 szt.	5902143141013
CON-RPZ15-120/25	150 mm, P 120; 25 szt.	5902143140986



Krażki ścierne na rzep z otworami

Sanding disks, Velcro, with holes
Круги шлифовальные на липучке, перфорированные
Klett Schleifscheiben, gelocht
Brusné kotouče suchý zip, perforované



Nr. ref.	Dane techniczne	Kod EAN
CON-RP13z-H24	125 mm, P 24; 5 szt.	5902143142089
CON-RP13z-H36	125 mm, P 36; 5 szt.	5902143142096
CON-RP13z-H40	125 mm, P 40; 5 szt.	5902143139966
CON-RP13z-H60	125 mm, P 60; 5 szt.	5902143139973
CON-RP13z-H80	125 mm, P 80; 5 szt.	5902143139980
CON-RP13z-H100	125 mm, P 100; 5 szt.	5902143139997
CON-RP13z-H120	125 mm, P 120; 5 szt.	5902143140009
CON-RP13z-H150	125 mm, P 150; 5 szt.	5902143140016
CON-RP13z-H180	125 mm, P 180; 5 szt.	5902143140023
CON-RP13z-H220	125 mm, P 220; 5 szt.	5902143140030
CON-RP13z-H240	125 mm, P 240; 5 szt.	5902143140047



Papiery ścierne DELTA na rzep

Delta sanding papers, Velcro
Шлифовальные листы с липучкой
Schleifpapiere DELTA mit Klett
Brúsne papiere DELTA so suchým zipsom



Nr. ref.	Dane techniczne	Kod EAN
CON-RPD-40	P 40; 5 szt.	5902143142102
CON-RPD-60	P 60; 5 szt.	5902143142119
CON-RPD-80	P 80; 5 szt.	5902143142126
CON-RPD-100	P 100; 5 szt.	5902143142133
CON-RPD-120	P 120; 5 szt.	5902143142140
CON-RPD-150	P 150; 5 szt.	5902143142157
CON-RPD-180	P 180; 5 szt.	5902143142164
CON-RPD-220	P 220; 5 szt.	5902143142171
CON-RPD-240	P 240; 5 szt.	5902143142188



Krażki fibrowe

Fiber discs
Круги фибровые
Fiberschleifer
Fíbrové kotúče



Nr. ref.	Dane techniczne	Kod EAN
CON-RPF-115/36	115 mm, P 36, 3 szt	5902143140856
CON-RPF-115/60	115 mm, P 60, 3 szt	5902143140863
CON-RPF-115/80	115 mm, P 80, 3 szt	5902143129097
CON-RPF-115/100	115 mm, P 100, 3 szt	5902143140870
CON-RPF-115/120	115 mm, P 120, 3 szt	5902143129103
CON-RPF-125/40	125 mm, P 40, 3 szt	5902143129110
CON-RPF-125/60	125 mm, P 60, 3 szt	5902143129127
CON-RPF-125/80	125 mm, P 80, 3 szt	5902143129134
CON-RPF-125/100	125 mm, P 100, 3 szt	5902143140887
CON-RPF-125/120	125 mm, P 120, 3 szt	5902143129141
CON-RPF-180/40	180 mm, P 40, 3 szt	5902143129158
CON-RPF-180/60	180 mm, P 60, 3 szt	5902143129165
CON-RPF-180/80	180 mm, P 80, 3 szt	5902143129172
CON-RPF-180/100	180 mm, P 100, 3 szt	5902143140894
CON-RPF-180/120	180 mm, P 120, 3 szt	5902143140542



Papiery ścierne na rzep z otworami

Sanding papers, Velcro with holes
Шлифовальные листы с липучкой, перфорированные
Schleifpapiere mit Klett, perforiert
Brúsne papiere, perforované, so suchým zipsom



Nr. ref.	Dane techniczne	Kod EAN
CON-RPS-H40V	93 x 185 mm, P 40; 5 szt.	5902143141990
CON-RPS-H60V	93 x 185 mm, P 60; 5 szt.	5902143142003
CON-RPS-H80V	93 x 185 mm, P 80; 5 szt.	5902143142010
CON-RPS-H100V	93 x 185 mm, P 100; 5 szt.	5902143142027
CON-RPS-H120V	93 x 185 mm, P 120; 5 szt.	5902143142034
CON-RPS-H150V	93 x 185 mm, P 150; 5 szt.	5902143142041
CON-RPS-H180V	93 x 185 mm, P 180; 5 szt.	5902143142058
CON-RPS-H220V	93 x 185 mm, P 220; 5 szt.	5902143142065
CON-RPS-H240V	93 x 185 mm, P 240; 5 szt.	5902143142072



Papiery ścierne z otworami

Sanding papers with holes
Шлифовальные листы, перфорированные
Schleifpapiere perforiert
Brúsne papiere, perforované



Nr. ref.	Dane techniczne	Kod EAN
CON-RPS-H40	93 x 230 mm, P 40; 5 szt.	5902143141907
CON-RPS-H60	93 x 230 mm, P 60; 5 szt.	5902143141914
CON-RPS-H80	93 x 230 mm, P 80; 5 szt.	5902143141921
CON-RPS-H100	93 x 230 mm, P 100; 5 szt.	5902143141938
CON-RPS-H120	93 x 230 mm, P 120; 5 szt.	5902143141945
CON-RPS-H150	93 x 230 mm, P 150; 5 szt.	5902143141952
CON-RPS-H180	93 x 230 mm, P 180; 5 szt.	5902143141969
CON-RPS-H220	93 x 230 mm, P 220; 5 szt.	5902143141976
CON-RPS-H240	93 x 230 mm, P 240; 5 szt.	5902143141983



Taśmy ścierne bezkońcowe

Sanding cloth belts
Бесконечные шлифовальные ленты
Schleifbands
Brusné pásy



Nr. ref.	Dane techniczne	Kod EAN
CON-RP457-40	75 x 457 mm, P 40; 3 szt.	5902143139843
CON-RP457-60	75 x 457 mm, P 60; 3 szt.	5902143139850
CON-RP457-80	75 x 457 mm, P 80; 3 szt.	5902143139867
CON-RP457-100	75 x 457 mm, P 100; 3 szt.	5902143139874
CON-RP457-120	75 x 457 mm, P 120; 3 szt.	5902143139881
CON-RP457-150	75 x 457 mm, P 150; 3 szt.	5902143139898
CON-RP533-40	75 x 533 mm, P 40; 3 szt.	5902143139904
CON-RP533-60	75 x 533 mm, P 60; 3 szt.	5902143139911
CON-RP533-80	75 x 533 mm, P 80; 3 szt.	5902143139928
CON-RP533-100	75 x 533 mm, P 100; 3 szt.	5902143139935
CON-RP533-120	75 x 533 mm, P 120; 3 szt.	5902143139942
CON-RP533-150	75 x 533 mm, P 150; 3 szt.	5902143139959



Papiery ścierne

Sanding papers
Шлифовальные листы
Schleifpapiere
Brúsne papiere



Nr. ref.	Dane techniczne	Kod EAN
CON-RPS-40	93 x 230 mm, P 40; 5 szt.	5902143141815
CON-RPS-60	93 x 230 mm, P 60; 5 szt.	5902143141822
CON-RPS-80	93 x 230 mm, P 80; 5 szt.	5902143141839
CON-RPS-100	93 x 230 mm, P 100; 5 szt.	5902143141846
CON-RPS-120	93 x 230 mm, P 120; 5 szt.	5902143141853
CON-RPS-150	93 x 230 mm, P 150; 5 szt.	5902143141860
CON-RPS-180	93 x 230 mm, P 180; 5 szt.	5902143141877
CON-RPS-220	93 x 230 mm, P 220; 5 szt.	5902143141884
CON-RPS-240	93 x 230 mm, P 240; 5 szt.	5902143141891



Papier ścierny

Sanding paper
Бумага наждачная
Schleifpapier
Brúsny papier

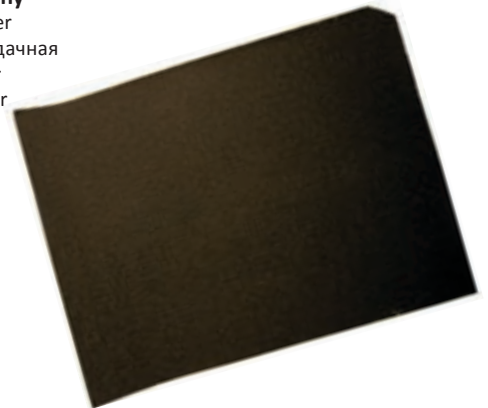

Nr. ref.	Dane techniczne	Kod EAN
CON-RPE-24	230 x 280 mm, P 24	5902143102304
CON-RPE-36	230 x 280 mm, P 36	5902143128663
CON-RPE-40	230 x 280 mm, P 40	5902143130802
CON-RPE-46	230 x 280 mm, P 46	5902143102311
CON-RPE-60	230 x 280 mm, P 60	5902143102328
CON-RPE-80	230 x 280 mm, P 80	5902143102335
CON-RPE-100	230 x 280 mm, P 100	5902143142515
CON-RPE-120	230 x 280 mm, P 120	5902143139744
CON-RPE-150	230 x 280 mm, P 150	5902143138464
CON-RPE-180	230 x 280 mm, P 180	5902143102274
CON-RPE-220	230 x 280 mm, P 220	5902143102281
CON-RPE-240	230 x 280 mm, P 240	5902143142201



Papiery ścierne
Sanding papers
Бумага наждачная
Schleifpapier
Brúсны papier

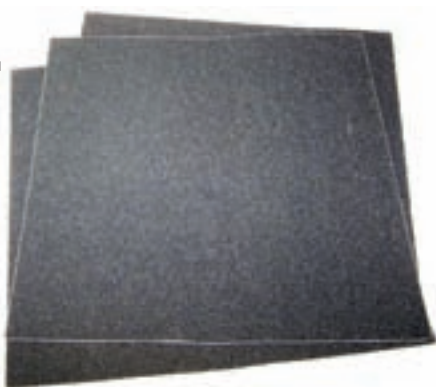

Nr. ref.	Dane techniczne	Kod EAN
CON-3941	P 80, P 120, P 320; 15 szt.	5902143134947



Papier ścierny
Sanding paper
Бумага наждачная
Schleifpapier
Brúсны papier



Nr. ref.	Dane techniczne	Kod EAN
CON-RRP-E1504	rolka 50 mb, 150 mm, P 40	5902143141518
CON-RRP-E1506	rolka 50 mb, 150 mm, P 60	5902143141525
CON-RRP-E1508	rolka 50 mb, 150 mm, P 80	5902143141532
CON-RRP-E1510	rolka 50 mb, 150 mm, P 100	5902143141549
CON-RRP-E1512	rolka 50 mb, 150 mm, P 120	5902143141556
CON-RRP-E1515	rolka 50 mb, 150 mm, P 150	5902143147633



Papier ścierny
Sanding paper
Бумага наждачная
Schleifpapier
Brúсны papier



Nr. ref.	Dane techniczne	Kod EAN
CON-RRP-Y1104	żółty: rolka 50 mb, 115 mm, P 40	5902143147640
CON-RRP-Y1106	żółty: rolka 50 mb, 115 mm, P 60	5902143141358
CON-RRP-Y1108	żółty: rolka 50 mb, 115 mm, P 80	5902143141365
CON-RRP-Y1110	żółty: rolka 50 mb, 115 mm, P 100	5902143147657
CON-RRP-Y1112	żółty: rolka 50 mb, 115 mm, P 120	5902143147664
CON-RRP-Y1115	żółty: rolka 50 mb, 115 mm, P 150	5902143147671
CON-RRP-Y1118	żółty: rolka 50 mb, 115 mm, P 180	5902143147688
CON-RRP-Y1122	żółty: rolka 50 mb, 115 mm, P 220	5902143141402



Papier ścierny wodoodporny
Waterproof sanding paper
Наждачная бумага, водостойкая
Schleifpapier, wasserfest
Brúсны papier, vode odolný



Nr. ref.	Dane techniczne	Kod EAN
CON-RPF-60	230 x 280 mm, P 60	5902143130567
CON-RPF-80	230 x 280 mm, P 80	5902143130574
CON-RPF-100	230 x 280 mm, P 100	5902143130581
CON-RPF-120	230 x 280 mm, P 120	5902143142218
CON-RPF-150	230 x 280 mm, P 150	5902143130598
CON-RPF-180	230 x 280 mm, P 180	5902143142225
CON-RPF-220	230 x 280 mm, P 220	5902143130604
CON-RPF-240	230 x 280 mm, P 240	5902143142232
CON-RPF-320	230 x 280 mm, P 320	5902143130628
CON-RPF-400	230 x 280 mm, P 400	5902143130635
CON-RPF-500	230 x 280 mm, P 500	5902143142249
CON-RPF-600	230 x 280 mm, P 600	5902143130642
CON-RPF-800	230 x 280 mm, P 800	5902143130659
CON-RPF-1000	230 x 280 mm, P 1000	5902143142256
CON-RPF-1200	230 x 280 mm, P 1200	5902143130666
CON-RPF-1500	230 x 280 mm, P 1500	5902143130673
CON-RPF-1800	230 x 280 mm, P 1800	5902143130819
CON-RPF-2000	230 x 280 mm, P 2000	5902143130796
CON-RPF-2200	230 x 280 mm, P 2200	5902143130680
CON-RPF-2500	230 x 280 mm, P 2500	5902143142263



Płótno ścierny
Sanding cloth
Шлифовальная шкурка
Schleiflein
Brúсны płótno

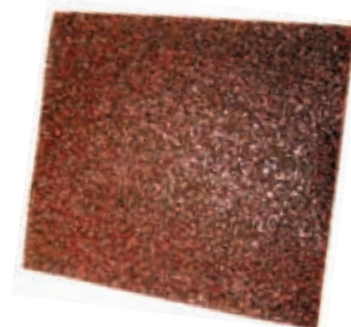

Nr. ref.	Dane techniczne	Kod EAN
CON-RPA-24	230 x 280 mm, P 24	5902143102373
CON-RPA-36	230 x 280 mm, P 36	5902143102380
CON-RPA-40	230 x 280 mm, P 40	5902143130543
CON-RPA-46	230 x 280 mm, P 46	5902143130826
CON-RPA-60	230 x 280 mm, P 60	5902143102397
CON-RPA-80	230 x 280 mm, P 80	5902143102403
CON-RPA-100	230 x 280 mm, P 100	5902143102410
CON-RPA-120	230 x 280 mm, P 120	5902143102427
CON-RPA-150	230 x 280 mm, P 150	5902143102434
CON-RPA-180	230 x 280 mm, P 180	5902143102441
CON-RPA-220	230 x 280 mm, P 220	5902143123699
CON-RPA-240	230 x 280 mm, P 240	5902143142195



Płótno ścierne

Sanding cloth
Шлифовальная шкурка
Schleiflein
Brúsne plátno



Nr. ref.	Dane techniczne	Kod EAN
CON-RRP-A1506	rolka 50 mb, 150 mm, P 60	5902143141488
CON-RRP-A1508	rolka 50 mb, 150 mm, P 80	5902143141495
CON-RRP-A1512	rolka 50 mb, 150 mm, P 120	5902143141501
CON-RRP-A2002	rolka 50 mb, 200 mm, P 24	5902143141419
CON-RRP-A2003	rolka 50 mb, 200 mm, P 36	5902143141426
CON-RRP-A2004	rolka 50 mb, 200 mm, P 40	5902143141433
CON-RRP-A2006	rolka 50 mb, 200 mm, P 60	5902143141440
CON-RRP-A2008	rolka 50 mb, 200 mm, P 80	5902143141457
CON-RRP-A2010	rolka 50 mb, 200 mm, P 100	5902143141464
CON-RRP-A2012	rolka 50 mb, 200 mm, P 120	5902143141471



Siatka ścierna

Sanding mesh
Сетка абразивная
Schleifgitter
Brusná sieťka



Nr. ref.	Dane techniczne	Kod EAN
CON-SS-40	P 40	5902143113348
CON-SS-60	P 60	5902143101024
CON-SS-80	P 80	5902143101031
CON-SS-100	P 100	5902143101048
CON-SS-120	P 120	5902143101055
CON-SS-150	P 150	5902143101062
CON-SS-180	P 180	5902143101079
CON-SS-220	P 220	5902143101086



Klocek do papieru ściernego

Rubber block for abrasive paper
Держатель наждачной бумаги
Schleiflotz
Držiak na brúsny papier



Nr. ref.	Dane techniczne	Kod EAN
CON-3975	65 x 125 mm	5902143116707



Mieszadło do farb lakierowane Trio

Paint mixer Trio
Миксер для краски Trio
Farbrührer Trio
Mieszadło farieb Trio



Nr. ref.	Dane techniczne	Kod EAN
A-M80	80 x 400 mm	



Mieszadło do farby

Paint mixer
Краска мешалкой
Farbrührer
Mieszadło farieb



Nr. ref.	Dane techniczne	Kod EAN
CON-AM-A2-80	80 x 400 mm	5902143137160
CON-AM-A3-100	100 x 500 mm	5902143137177



Wełna stalowa

Steel wool
Стальная стружка
Stahlwolle
Drôtenka oceľová



Nr. ref.	Dane techniczne	Kod EAN
CON-SW-05200	200 g	5902143142584



Mieszadło do zaprawy

Mortar mixer
Миксер для цемента
Mörtelrührer
Mieszadło na maltu



Nr. ref.	Dane techniczne	Kod EAN
CON-AM-B2-80	80 x 400 mm	5902143137153
CON-AM-B3-100	100 x 500 mm	5902143137184



Mieszadło do zaprawy

Mortar mixer
Миксер для цемента
Mörtelrührer
Miešadlo na maltu



Nr. ref.	Dane techniczne	Kod EAN
CON-AM-C1-80	80 x 400 mm	5902143137191
CON-AM-C2-100	100 x 500 mm	5902143137207
CON-AM-C3-120	120 x 600 mm	5902143137214
CON-AM-D1-80	80 x 450 mm	5902143137221
CON-AM-D2-100	100 x 450 mm	5902143137238



Mieszadło do gipsu

Plaster mixer
Миксер для штукатурки
Gipsrührer
Miešadlo na omietky

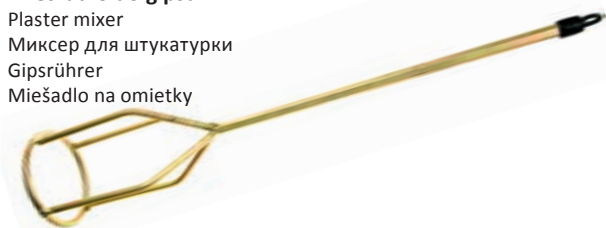

Nr. ref.	Dane techniczne	Kod EAN
CON-AM-E1-80	80 x 400 mm	5902143137245
CON-AM-E2-100	100 x 500 mm	5902143137252



Mini wiertła

Mini drills
Мини-свёрла
Mini-Bohrer
Mini vrtáky



Nr. ref.	Dane techniczne	Kod EAN
CON-MTA-01	0,6-2,3 mm; 10 szt.; uchwyt 2,35 mm (1/8")	5902143118794



Mini frezy

Mini mills
Мини-фрезы
Mini-Fräser
Mini frézy



Nr. ref.	Dane techniczne	Kod EAN
CON-MTA-02	8 szt.; uchwyt 2,35 mm (1/8")	5902143118800



Mini tarcze

Mini disks
Мини-круги
Mini-Scheiben
Mini kotúče



Nr. ref.	Dane techniczne	Kod EAN
CON-MTA-03	9 szt.; uchwyt 2,35 mm (1/8")	5902143118817



Mini kamienie szlifierskie

Mini grinding stones
Мини-камни шлифовальные
Mini-Schleifsteine
Mini brusne kamene



Nr. ref.	Dane techniczne	Kod EAN
CON-MTA-04	14 szt.; uchwyt 2,35 mm (1/8")	5902143118824



Mini krawki, bębny

Mini wheels, drums
Мини-круги, мини-барабаны шлифовальные
Mini-Rollen, Trommeln
Mini krúžky, bubny



Nr. ref.	Dane techniczne	Kod EAN
CON-MTA-05	13 szt.; uchwyt 2,35 mm (1/8")	5902143118831



Mini szczotki

Mini brushes
Мини-щётки
Mini-Bürsten
Mini kefy



Nr. ref.	Dane techniczne	Kod EAN
CON-MTA-06	10 szt.; uchwyt 2,35 mm (1/8")	5902143118848



Mini wiertła, frezy, szczotki

Mini drills, cutters, brushes
Мини-свёрла, мини-фрезы, мини-щётки
Mini-Bohrer, -Fräser, -Bürsten
Mini vrtáky, frézy, kefy



Nr. ref.	Dane techniczne	Kod EAN
CON-MTA-09	150 szt.; uchwyt 2,35 mm (1/8")	5902143118879

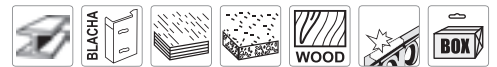

Mini sztyfty polerskie

Mini polishing pins
Мини-инструменты для полировки
Mini-Polierstifte
Mini leštiace hroty



Nr. ref.	Dane techniczne	Kod EAN
CON-MTA-07	5 szt.; uchwyt 2,35 mm (1/8")	5902143118855



Mini bębny, tarcze

Mini drums; disks
Мини-барабаны шлифовальные, мини-круги
Mini-Trommeln, Scheiben
Mini bubny, kotúče



Nr. ref.	Dane techniczne	Kod EAN
CON-MTA-10	206 szt. ; uchwyt 2,35 mm (1/8")	5902143118886



Mini sztyfty filcowe

Mini felts
Мини-инструмент фетровый для полировки
Mini-Filzstifte
Mini leštiace hroty Plstové



Nr. ref.	Dane techniczne	Kod EAN
CON-MTA-08	7 szt.; uchwyt 2,35 mm (1/8")	5902143118862



Mini tarcze, kamienie

Mini disks, stones
Мини-круги, мини-камни шлифовальные
Mini-Scheiben, Steine
Mini kotúče, kamene



Nr. ref.	Dane techniczne	Kod EAN
CON-MTA-11	134 szt. ; uchwyt 2,35 mm (1/8")	5902143118893



Mini frezy, bębny

Mini cutters, drums
 Мини-фрезы, мини-барабаны шлифовальные
 Mini-Fräser, Trommeln
 Mini frézy, bubny



Nr. ref.	Dane techniczne	Kod EAN
CON-MTA-12	100 szt.; uchwyt 2,35 mm (1/8")	5902143118909



Mini piły, krążki

Mini saw blades, disks
 Мини-пилы, мини-круги
 Mini-Sägen, Rollen
 Mini piły, krążki



Nr. ref.	Dane techniczne	Kod EAN
CON-MTA-13	52 szt. ; uchwyt 2,35 mm (1/8")	5902143118916



Pasta polerska

Polishing compound
 Паста полировальная
 Polierpaste
 Leštiaca pasta



Nr. ref.	Dane techniczne	Kod EAN
CON-MTA-14	P 180; szara	5902143118923
CON-MTA-15	P 180; czerwona	5902143118930
CON-MTA-16	P 60; zielona	5902143118947
CON-MTA-17	P 120; zielona	5902143118954
CON-MTA-18	P 180; zielona	5902143118961
CON-MTA-19	P 400; zielona	5902143118978



Przystawka do wiercenia pionowego

Vertical drilling attachment
 Приставка для вертикального сверления
 Bohrständer vertikal
 Stojan na vrtačku viacúčelový



Nr. ref.	Kod EAN
CON-STJ-01	5902143115991



Przystawka do frezowania rowków w ścianach

Grooving attachment
 Приставка для фрезеровки канавок в стенах
 Fräser für Mauermeißel
 Nástavec na vrtačku



Nr. ref.	Kod EAN
CON-STJ-02	5902143116028



Pompa do płynów na wiertarkę

Drill pump
 Ручной насос для дрели
 Pumpe für Bohrmaschine
 Čerpadlo na vrtačku



Nr. ref.	Kod EAN
CON-WDP-01	5902143130307



Stojak do szlifierki

Grinder stand
 Стойка для шлифовальной машины
 Trennstander für Winkelschleifer
 Stojan na uhlovú brúsku



Nr. ref.	Dane techniczne	Kod EAN
CON-STJ-05	115 x 125 mm	5902143116004
CON-STJ-06	230 mm	5902143116011



Stojak do wiertarki

Drill stand
 Стойка для дрели
 Bohrmaschinenstander
 Stojan do vrtačku



Nr. ref.	Dane techniczne	Kod EAN
CON-STJ-103	38-43 mm	5902143106296



Wycinarka trzpieniowa do blach

Sheet metal nibbler attachment
 Вырезной инструмент для листового металла
 Blechschere
 Rezačka plechu



Nr. ref.	Kod EAN
CON-SC-01	5902143119548
CON-SC-02	5902143119555



Noże do wycinarki trzpieniowej

Cutters for sheet metal nibbler
 Лезвия для вырезного инструмента
 Messern für Blechschere
 Nože pre rezačky plechu



Nr. ref.	Dane techniczne	Kod EAN
CON-SC-03	2 szt. do CON-SC-01, CON-SC-02	5902143119562



Klucz do szlifierki kątovej

Angle grinder key
 Ключ для УШМ
 Winkelschleifer schlüssel
 Klíč úplný



Nr. ref.	Dane techniczne	Kod EAN
CON-AKY-01	115/125 mm	5902143137283



Klucz do szlifierki kątovej

Angle grinder key
 Ключ для УШМ
 Winkelschleifer schlüssel
 Klíč úplný



Nr. ref.	Dane techniczne	Kod EAN
CON-AKY-02	180/230 mm	5902143141679



Klucz płasko-oczkowy

Combination wrench
Ключ комбинированный
Ring-Maulschlüssel
Klíč očko-plochý



Nr. ref.	Dane techniczne	Kod EAN
CON-IP/O-6	6 mm	5902143120971
CON-IP/O-7	7 mm	5902143120988
CON-IP/O-8	8 mm	5902143120995
CON-IP/O-9	9 mm	5902143121015
CON-IP/O-10	10 mm	5902143121022
CON-IP/O-11	11 mm	5902143121039
CON-IP/O-12	12 mm	5902143121046
CON-IP/O-13	13 mm	5902143121053
CON-IP/O-14	14 mm	5902143121060
CON-IP/O-15	15 mm	5902143121077
CON-IP/O-16	16 mm	5902143121084
CON-IP/O-17	17 mm	5902143121091
CON-IP/O-18	18 mm	5902143121107
CON-IP/O-19	19 mm	5902143121114
CON-IP/O-20	20 mm	5902143121121
CON-IP/O-21	21 mm	5902143121138
CON-IP/O-22	22 mm	5902143121145
CON-IP/O-23	23 mm	5902143121152
CON-IP/O-24	24 mm	5902143121169
CON-IP/O-25	25 mm	5902143143246
CON-IP/O-27	27 mm	5902143121176
CON-IP/O-30	30 mm	5902143121183
CON-IP/O-32	32 mm	5902143121190



Klucz płaski

Double open end wrench
Ключ рожковый
Doppel-Maulschlüssel
Klíč obojstranný otvorený



Nr. ref.	Dane techniczne	Kod EAN
CON-IP-6/7	6 x 7 mm	5902143120827
CON-IP-8/9	8 x 9 mm	5902143120834
CON-IP-10/11	10 x 11 mm	5902143120841
CON-IP-12/13	12 x 13 mm	5902143120858
CON-IP-14/15	14 x 15 mm	5902143120865
CON-IP-16/17	16 x 17 mm	5902143120872
CON-IP-18/19	18 x 19 mm	5902143120889
CON-IP-20/22	20 x 22 mm	5902143120896
CON-IP-21/23	21 x 23 mm	5902143120902
CON-IP-24/27	24 x 27 mm	5902143120919
CON-IP-25/28	25 x 28 mm	5902143120926
CON-IP-30/32	30 x 32 mm	5902143120933



Klucze płaskie

Double open end wrenches
Ключи рожковые
Doppel-Maulschlüssel Satz
Klíče otvorené, obojstranné



Nr. ref.	Dane techniczne	Kod EAN
CON-IP-6107	6,0-17 mm; 6 szt.	5902143120940
CON-IP-6108	6,0-22 mm; 8 szt.	5902143120957
CON-IP-6133	6,0-32 mm; 12 szt.	5902143120964



Klucze płasko-oczkowe

Combination wrenches
Ключи комбинированные
Ring-Maulschlüssel Satz
Klíče očko-ploché



Nr. ref.	Dane techniczne	Kod EAN
CON-IPO-6317	6,0-17,0 mm; 6 szt.	5902143121206
CON-IPO-6319	6,0-19,0 mm; 8 szt.	5902143121213
CON-IPO-6333	6,0-22,0 mm; 12 szt.	5902143121220
CON-IPO-6334	6,0-32,0 mm; 25 szt.	5902143121219



Klucz oczkowy głęboko odsadzony

Ring wrench, deep offset
Ключ накидной, изогнутый
Doppel-Ringschlüssel tief gekröpft
Klíč očkový hlbooko vyhnutý



Nr. ref.	Dane techniczne	Kod EAN
CON-IO-6/7	6 x 7 mm	5902143121237
CON-IO-8/9	8 x 9 mm	5902143121244
CON-IO-10/11	10 x 11 mm	5902143121251
CON-IO-12/13	12 x 13 mm	5902143121268
CON-IO-14/15	14 x 15 mm	5902143121275
CON-IO-16/17	16 x 17 mm	5902143121282
CON-IO-18/19	18 x 19 mm	5902143121299
CON-IO-20/22	20 x 22 mm	5902143121305
CON-IO-21/23	21 x 23 mm	5902143121312
CON-IO-24/27	24 x 27 mm	5902143121329
CON-IO-30/32	30 x 32 mm	5902143121336

Cr-V



Klucze rurowe

Tubular socket wrenches
Трубчатые ключи
Rohrschlüssel
Klíče trubkové



Nr. ref.	Dane techniczne	Kod EAN
CON-KR-01	6,0-17 mm; 6 szt.	5902143119623
CON-KR-02	6,0-22 mm; 8 szt.	5902143119630



Klucze oczkowe głęboko odsadzone

Ring wrenches, deep offset
Ключи накидные, изогнутые
Doppel-Ringschlüssel tief gekröpft
Klíče očkové hlbooko vyhnute



Nr. ref.	Dane techniczne	Kod EAN
CON-IO-6217	6-17 mm; 6 szt.	5902143121343
CON-IO-6219	6-22 mm; 8 szt.	5902143121350
CON-IO-6233	6-32 mm; 12 szt.	5902143121367

Cr-V



Klucz hydrauliczny do rur typ stillson

Pipe wrench „Stillson”
Ключ трубный разводной «Stillson»
Hydraulikschlüssel verstellbar
Klíč hydraulický do rúr typ stillson



Nr. ref.	Dane techniczne	Kod EAN
CON-7580	250 mm	5902143120506
CON-7582	300 mm	5902143120513
CON-7584	350 mm	5902143120520
CON-7588	450 mm	5902143120537
CON-7589	600 mm	5902143121831

Klucz do rur, typ szwedzki

Swedish pipe wrench
Ключ трубный, типа Шведский
Schwedische Rohrzange
Hasák, švédsky vzor



Nr. ref.	Dane techniczne	Kod EAN
CON-PW-1	1"	5902143112723
CON-PW-1,5	1,5"	5902143112730
CON-PW-2	2"	5902143112747

Klucz nastawny typu Szwed

Adjustable wrench
Ключ разводной «Шведский»
Verstellbarer Einmaulschlüssel
Nastavitelný klíč



Nr. ref.	Dane techniczne	Kod EAN
CON-KN-06	6" (150 mm)	5902143112938
CON-KN-08	8" (200 mm)	5902143112945
CON-KN-10	10" (250 mm)	5902143112952
CON-KN-12	12" (300 mm)	5902143112969



Klucze sześciokątne wydłużone

Hex key wrenches long
Ключи шестигранные сверхдлинные
Sechskantschlüssel verlängert
Klíče šestúholníkové predĺžené



Nr. ref.	Dane techniczne	Kod EAN
CON-IL	1,5-10 mm; 9 szt.	5902143109068



Cr-V

Long



Klucze sześciokątne wydłużone z końcówką kulistą

Ball head hex key wrenches long
Ключи шестигранные сверхдлинные с шаровым наконечником
Sechskantschlüssel verlängert mit Kugelendstück
Klúče šesťuholníkové predĺžený s guľatou koncovkou



Nr. ref.	Dane techniczne	Kod EAN
CON-ILB	1,5-10 mm; 9 szt.	5902143109051









Klucze Torx wydłużone

Torx® wrenches, long
Ключи TORX сверхдлинные
Torx-Schlüssel verlängert
Klúče Torx predĺžený



Nr. ref.	Dane techniczne	Kod EAN
CON-TL	T10-50; 9 szt.	5902143109075







Wkrętak krzyżowy

Screwdriver for cross head screws
Отвёртка крестовая
Schraubendreher Kreuzschlitz
Skrutkovač krížový



Nr. ref.	Dane techniczne	Kod EAN
CON-WKA-PH0	PH0 x 75 mm	5902143130376
CON-WKA-PH1	PH1 x 100 mm	5902143130383
CON-WKA-PH2	PH2 x 125 mm	5902143130390
CON-WKA-PH3	PH3 x 150 mm	5902143130406







Wkrętak krzyżowy

Screwdriver for cross head screws
Отвёртка крестовая
Schraubendreher Kreuzschlitz
Skrutkovač krížový



Nr. ref.	Dane techniczne	Kod EAN
CON-WK-PH0	PH0 x 75 mm	5902143125402
CON-WK-PH1	PH1 x 100 mm	5902143125419
CON-WK-PH2	PH2 x 125 mm	5902143125426
CON-WK-PH3	PH3 x 150 mm	5902143125433

Wkrętak krzyżowy, sztuba

Screwdriver for cross head screws, short
Отвёртка крестовая, короткая
Schraubendreher Kreuzschlitz, kurz
Skrutkovač krížový, krátky



Nr. ref.	Dane techniczne	Kod EAN
CON-WK-PHS2	PH2 x 38 mm	5902143125488







Wkrętak krzyżowy

Screwdriver for cross head screws
Отвёртка крестовая
Schraubendreher Kreuzschlitz
Skrutkovač krížový



Nr. ref.	Dane techniczne	Kod EAN
CON-WKA-PZ1	PZ1 x 100 mm	5902143130413
CON-WKA-PZ2	PZ2 x 125 mm	5902143130420
CON-WKA-PZ3	PZ3 x 150 mm	5902143130437







Wkrętak krzyżowy

Screwdriver for cross head screws
Отвёртка крестовая
Schraubendreher Kreuzschlitz
Skrutkovač krížový



Nr. ref.	Dane techniczne	Kod EAN
CON-WK-PZ1	PZ1 x 100 mm	5902143125440
CON-WK-PZ2	PZ2 x 125 mm	5902143125457
CON-WK-PZ3	PZ3 x 150 mm	5902143125464







Wkrętak płaski

Screwdriver for slotted head screws
Отвёртка плоская
Schraubendreher Flachschriff
Skrutkovač plochý



Nr. ref.	Dane techniczne	Kod EAN
CON-WKA-SL3	SL3,0 x 75 mm	5902143139683
CON-WKA-SL4	SL4,0 x 75 mm	5902143139690
CON-WKA-SL5	SL5,0 x 75 mm	5902143130345
CON-WKA-SL5/100	SL5,0 x 100 mm	5902143139706
CON-WKA-SL6	SL6,0 x 125 mm	5902143130352
CON-WKA-SL8	SL8,0 x 150 mm	5902143130369





Wkrętak płaski

Screwdriver for slotted head screws
Отвёртка плоская
Schraubendreher Flachschrift
Skrutkovač plochý

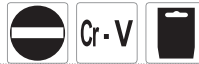

Nr. ref.	Dane techniczne	Kod EAN
CON-WK-SL5	SL5,0 x 75 mm	5902143125358
CON-WK-SL6	SL6,0 x 125 mm	5902143125365
CON-WK-SL8	SL8,0 x 150 mm	5902143125372



Wkrętak płaski, sztuba

Screwdriver for slotted head screws, short
Отвёртка плоская, короткая
Schraubendreher Flachschrift, kurz
Skrutkovač plochý, krátky



Nr. ref.	Dane techniczne	Kod EAN
CON-WK-SLS6	SL6,0 x 38 mm	5902143125495



Wkrętaki, próbnik

Screwdrivers; tester
Отвёртки; отвёртка-пробник
Schraubendreher; Tester
Skrutkovače; skůšač



Nr. ref.	Dane techniczne	Kod EAN
CON-WK-Z3	SL6,0 x 150 mm, PH2 x 100 mm; próbnik 140 mm; 3 szt.	5902143125471



Wkrętaki

Screwdrivers
Отвёртки
Schraubendreher
Skrutkovače



Nr. ref.	Dane techniczne	Kod EAN
CON-WK-Z6	SL3,0x75 mm, SL5x100 mm, SL6x150 mm; PH0x75 mm, PH1x100 mm, PH2x150 mm; 6 szt.	5902143125341



Wkrętak z uchwytem „T”

T-handle screwdriver
Отвёртка T-образная
Schraubendreher mit T-Griff
Skrutkovač T-ruk



Nr. ref.	Kod EAN
CON-5218	5902143133063



Wykrętaki do urwanych śrub

Screw extractors
Экстракторы сорванных винтов
Schraubenausdreher Satz
Vyťahovač skrutiek



Nr. ref.	Dane techniczne	Kod EAN
CON-SCE-Z5	3-19 mm; 5 szt.	5902143133056



Wkrętak uderowy z sześcioma końcówkami

Impact screwdriver, 6 bits
Отвёртка ударная, 6 бит
Schlagschrauber, 6 Bits
Nárazový skrutkovač, 6 bitov



Nr. ref.	Dane techniczne	Kod EAN
CON-WKU-5701	7 szt.	5902143122531



Szczypce uniwersalne

Multi purpose pliers
Пассатижи
Kombizange
Kliešte univerzálne



Nr. ref.	Dane techniczne	Kod EAN
CON-SZ-7009	160 mm	5902143117117
CON-SZ-7010	180 mm	5902143117124
CON-SZ-7014	200 mm	5902143117131



Obcęgi do gwoździ

Carpenter's pincers
Клеши-гвоздодёры
Beißzange
Kliešte do klincov



Nr. ref.	Dane techniczne	Kod EAN
CON-SZ-7108	200 mm	5902143117223



Szczypce zaciskowe uniwersalne

Multi purpose clamping pliers
Клеши зажимные универсальные
Gripzange
Kliešte univerzálne



Nr. ref.	Dane techniczne	Kod EAN
CON-SZ-7210	250 mm	5902143117254



Szczypce czołowe

End cutting nippers
Кусачки торцевые
Stirnzange
Kliešte čelné



Nr. ref.	Dane techniczne	Kod EAN
CON-SZ-7115	180 mm	5902143117247



Szczypce zaciskowe uniwersalne z regulacją

Adjustable multi purpose clamping pliers
Клеши зажимные универсальные с регулировкой
Gripzange, verstellbar
Kliešte univerzálne s reguláciou



Nr. ref.	Dane techniczne	Kod EAN
CON-SZ-7215	250 mm	5902143117261



Szczypce tynkarskie

End cutting nippers
Клеши строительные
Putzerzange
Kliešte omietkarské



Nr. ref.	Dane techniczne	Kod EAN
CON-SZ-7125	250 mm	5902143117230



Szczypce boczne

Diagonal cutting nippers
Кусачки боковые
Seitenzange
Kliešte bočné



Nr. ref.	Dane techniczne	Kod EAN
CON-SZ-7038	160 mm	5902143117094
CON-SZ-7039	200 mm	5902143117100



Szczypce płaskie

Flat nose pliers
Плоскогубцы
Flachzange
Kliešte ploché



Nr. ref.	Dane techniczne	Kod EAN
CON-SZ-7046	160 mm	5902143117186



Szczypce wydłużone proste

Long needle nose pliers, straight
Клещи с удлинёнными губками, прямые
Zange verlängert, gerade
Kliešte predĺžené, rovné



Nr. ref.	Dane techniczne	Kod EAN
CON-SZ-7025	160 mm	5902143117148
CON-SZ-7026	200 mm	5902143117155



Szczypce wydłużone wygięte

Long needle nose pliers, bent
Клещи с удлинёнными губками, изогнутые
Zange verlängert, gebogen
Kliešte predĺžené, zahnuté

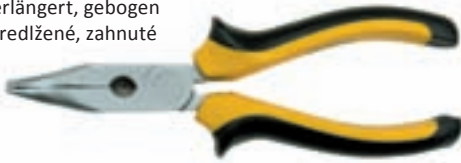

Nr. ref.	Dane techniczne	Kod EAN
CON-SZ-7029	160 mm	5902143117162
CON-SZ-7030	200 mm	5902143117179



Szczypce okrągłe

Duckbill pliers
Круглогубцы
Rundzange
Kliešte okrúhle



Nr. ref.	Dane techniczne	Kod EAN
CON-SZ-7050	160 mm	5902143117193



Szczypce do rur

Slip joint pliers
Клещи трубные
Rohrzange
Kliešte do rúr



Nr. ref.	Dane techniczne	Kod EAN
CON-SZ-7058	250 mm	5902143117209



Szczypce do usuwania izolacji

Adjustable wire strippers
Клещи для снятия изоляции
Abisolierzange
Kliešte do odstraňovania izolácie



Nr. ref.	Dane techniczne	Kod EAN
CON-SZ-7002	160 mm	5902143117216



Szczypce do izolacji - automatyczne

Automatic wire strippers
Клещи для снятия изоляции автоматические
Abisolierzange - automatisch
Kliešte do izolácie - automatické



Nr. ref.	Kod EAN
CON-SZI-06	5902143121602



Gwintowniki i narzynki z oprawkami

Screw taps and round dies with holder
Метчики и плашки с воротками
Gewindebohrer und Schneideisen mit Fassungen
Závitníky a závitnice s objímkami



Nr. ref.	Dane techniczne	Kod EAN
CON-9179	M3-M12; 20 szt.	5902143109341



Gwintowniki i narzynki z oprawkami

Screw taps and round dies with holder
 Метчики и плашки с воротками
 Gewindebohrer und Schneideisen mit Fassungen
 Závítníky a závítnice s objímkami



Nr. ref.	Dane techniczne	Kod EAN
CON-9180	M3-M12; 40 szt.	5902143118633



Imadło stałe stalowe

Steel fixed vice
 Тиски стальные стационарные
 Stahlschraubstock mit festen
 Zverák ocelový, pevný

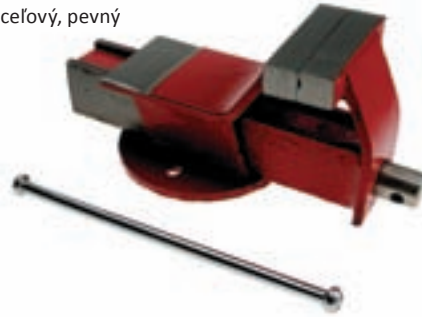

Nr. ref.	Dane techniczne	Kod EAN
CON-BVS-S80	80 mm	5902143129820
CON-BVS-S100	100 mm	5902143129837
CON-BVS-S125	125 mm	5902143122241
CON-BVS-S150	150 mm	5902143122258
CON-BVS-S200	200 mm	5902143122265



Imadło stałe z kowadłem

Fixed vice with anvil
 Тиски стационарные с наковальней
 Schraubstock mit festen und Amboss
 Zverák pevný s kovadlinou



Nr. ref.	Dane techniczne	Kod EAN
CON-BV-9210	100 mm	5902143118527
CON-BV-9215	125 mm	5902143118534
CON-BV-9220	150 mm	5902143118541



Imadło stalowe obrotowe

Steel swivel base vice
 Тиски стальные поворотные
 Stahlschraubstock drehbar
 Zverák ocelový, otočný



Nr. ref.	Dane techniczne	Kod EAN
CON-BVS-O80	80 mm	5902143129806
CON-BVS-O100	100 mm	5902143129813
CON-BVS-O125	125 mm	5902143122272
CON-BVS-O150	150 mm	5902143122289
CON-BVS-O200	200 mm	5902143122296



Imadło obrotowe z kowadłem

Swivel-base vice with anvil
 Тиски поворотные с наковальней
 Schraubstock drehbar mit Amboss
 Zverák otočný s kovadlinou



Nr. ref.	Dane techniczne	Kod EAN
CON-BV-9230	100 mm	5902143118558
CON-BV-9235	125 mm	5902143118565
CON-BV-9240	150 mm	5902143118572



Imadło mini

Mini vice
 Тиски-мини
 Mini-Schraubstock
 Zverák mini



Nr. ref.	Dane techniczne	Kod EAN
CON-BVM-0111	25 mm	5902143121497
CON-BVM-0117	50 mm	5902143121527
CON-BVM-0119	40 mm	5902143121503
CON-BVM-0148	50 mm	5902143121510



Młotek

Hammer
Молоток
Hammer
Kladivo



Nr. ref.	Dane techniczne	Kod EAN
CON-2001	100 gr	5902143114376
CON-2002	200 gr	5902143114383
CON-2003	300 gr	5902143114390
CON-2004	400 gr	5902143114406
CON-2005	500 gr	5902143114413
CON-2008	800 gr	5902143114420
CON-2010	1000 gr	5902143114437
CON-2015	1500 gr	5902143114444
CON-2020	2000 gr	5902143114451



Młotek z wyciągaczem do gwoździ

Claw hammer
Молоток с гвоздодёром
Hammer mit Nagelauzieher
Kladivo s vyťahovačom klinco



Nr. ref.	Dane techniczne	Kod EAN
CON-HH-SC27	27 mm	5902143134497



Młotek

Hammer
Молоток
Hammer
Kladivo



Nr. ref.	Dane techniczne	Kod EAN
CON-2003-FI	300 gr	5902143114468
CON-2005-FI	500 gr	5902143114475
CON-2008-FI	800 gr	5902143114482
CON-2010-FI	1000 gr	5902143114499



Młotek murarski typ berliński

Brick hammer
Молоток-кирочка «Берлинский»
Maurerhammer Typ Berlin
Kladivo murárske berlínske



Nr. ref.	Dane techniczne	Kod EAN
CON-HH-SB27	27 mm	5902143134510



Młotek ciesielski

Curve claw nail hammer
Молоток плотничный
Zimmererhammer
Kladivo tesárske



Nr. ref.	Dane techniczne	Kod EAN
CON-HH-R27	27 mm	5902143134503



Młotek murarski typ reński

Bricklayer's hammer
Молоток-кирочка «Рейнский»
Maurerhammer Typ Rhein
Kladivo murárske rýnske



Nr. ref.	Dane techniczne	Kod EAN
CON-HH-SR27	27 mm	5902143134527



Młotek gumowy

Rubber mallet
Резиновый молоток
Gummihammer
Gumové kladivo



Nr. ref.	Dane techniczne	Kod EAN
CON-HR-50	50 mm	5902143134459
CON-HR-65	65 mm	5902143134466
CON-HR-90	90 mm	5902143134473

GUMA

Siekiera

Axe
Топор
Axt
Sekera



Nr. ref.	Dane techniczne	Kod EAN
CON-3920M	570 gr	5902143121411



Przecinak z osłoną

Cold chisel with hand guard
Зубило с протектором
Maurermeissel mit Handschutz
Sekáč s chráničom



Nr. ref.	Dane techniczne	Kod EAN
CON-CH-9852	250 x 19 mm	5902143130062
CON-CH-9853	300 x 19 mm	5902143121534
CON-CH-9854	400 x 19 mm	5902143121541
CON-CH-9855	500 x 19 mm	5902143121558
CON-CH-9856	450 x 19 mm	5902143130086
CON-CH-9857	350 x 19 mm	5902143130079



Przecinak z osłoną

Cold chisel with hand guard
Зубило с протектором
Maurermeissel mit Handschutz
Sekáč s chráničom



Nr. ref.	Dane techniczne	Kod EAN
CON-CH-525	250 mm	5902143141686
CON-CH-530	300 mm	5902143134596



Przecinak murarski z osłoną

Mason's chisel with hand guard
Зубило с протектором
Maurermeissel mit Handschutz
Sekáč s chráničom



Nr. ref.	Dane techniczne	Kod EAN
CON-0008	230 x 60 x 16 mm	5902143118749



Przebijak z osłoną

Punch with rubber handle
Кернер с протектором
Dorn mit Schutz
Priebojník s chráničom



Nr. ref.	Dane techniczne	Kod EAN
CON-CH-725	250 mm	5902143141693
CON-CH-730	300 mm	5902143134602



Łom z gumową rączką

Crowbar with rubber handle
Лом-гвоздодёр с резиновой ручкой
Brecheisen mit Gummigriff
Páčidlo s gumovou rukoväťou



Nr. ref.	Dane techniczne	Kod EAN
CON-WB-9805	300 mm	5902143134589



Łom

Crowbar
Лом-гвоздодёр
Brecheisen
Páčidlo



Nr. ref.	Dane techniczne	Kod EAN
CON-WB-9810	600 mm	5902143134572



Przyssawka do szyb aluminiowa podwójna

2 - cups aluminium glass suction
Присоска для стекла алюминиевая, двойная
Saugnapfhalter, Alu
Prísavka na sklo, hliníková



Nr. ref.	Dane techniczne	Kod EAN
CON-UCS-02	120 mm; maks. udźwig p/p: 85/100 kg	5902143120681



Przyssawka do szyb aluminiowa potrójna

3 - cups aluminium glass suction
Присоска для стекла алюминиевая, тройная
Saugnapfhalter, Alu
Prísavka na sklo, hliníková



Nr. ref.	Dane techniczne	Kod EAN
CON-UCS-03	120 mm; maks. udźwig p/p: 140/155 kg	5902143130253



Przyssawka do szyb aluminiowa pojedyncza

1 - cup aluminium glass suction
Присоска для стекла алюминиевая, одиночная
Saugnapfhalter, Alu
Prísavka na sklo, hliníková



Nr. ref.	Dane techniczne	Kod EAN
CON-UCS-01	120 mm; maks. udźwig p/p: 35/50 kg	5902143120674



Guma do przyssawki do szyb

Rubber for glass suction cups
Резина для присосок
Gummi für Saugnapfhalter
Gumová přísavka



Nr. ref.	Kod EAN
CON-UCS-G	5902143142331

GUMA

Taśmy izolacyjne czarne

Insulating tapes
Изолянты
Isolierbänder
Izolačné pásky



Nr. ref.	Dane techniczne	Kod EAN
CON-9510	19 x 0,13 mm x 10 m; 10 szt.	5902143133278
CON-9510-1	19 x 0,13 mm x 10 m	5902143137481

Opaski zaciskowe do kabli

Tie wraps
Стяжки для кабелей
Kabelbinder
Vázací svorky



Nr. ref.	Dane techniczne	Kod EAN
CON-9591	300 mm; 50 szt.	5902143132974
CON-9593	200 mm; 50 szt.	5902143132943
CON-9594	300 mm; 50 szt.	5902143132950
CON-9595	25 szt. x 90/120/190 mm; 75 szt.	5902143132967



Taśmy izolacyjne

Insulating tapes
Изолянты
Isolierbänder
Izolačné pásky



Nr. ref.	Dane techniczne	Kod EAN
CON-9550	19 x 0,13 mm x 3 m; 6 szt.	5902143133285

Ołówek stolarski

Carpenter's pencil
Плотницкий карандаш
Zimmermannsbleistift
Ceruzka tesárska



Nr. ref.	Dane techniczne	Kod EAN
5518	180 mm	5902143100683

Taśmy teflonowe

Teflon insulating tapes
Изолянты
Teflon-Isolierbänder
Teflonové izolačné pásky



Nr. ref.	Dane techniczne	Kod EAN
CON-TF-203:	12 mm x 10 m; 3 szt.	5902143134831



Wiertarka ręczna z przekładnią

Hand drill with gear
Дрель ручная
Handbohrmaschine
Vřtačka ručná



Nr. ref.	Dane techniczne	Kod EAN
CON-0039	uchwytyt 3/8"	5902143118640



Kreda fluorescencyjna

Fluorescent chalk
Мел флуоресцентный
Fluoreszierende Kreide
Krieda fluorescenčná



Nr. ref.

Dane techniczne

Kod EAN

CON-KZ-AF5

A2; 5 szt.

5902143142683



Kreda kolorowa

Coloured chalk
Мел цветной
Farbige Kreide
Krieda farebná



Nr. ref.

Dane techniczne

Kod EAN

CON-KZ-MK12

12 szt.

5902143142669



Kreda niezmywalna

Unwashable chalk
Мел моющихся
Waschbar Kreide
Krieda neumývateľna



Nr. ref.

Dane techniczne

Kod EAN

CON-KZ-ANB1

A1; 24 szt.

5902143142676



Stolik warsztatowy z podziałką

Workshop table with scale
Верстак складной
Werkstattbank
Skladací truhlársky stolík



Nr. ref.

Dane techniczne

Kod EAN

CON-PA229

60,6 x 64 x 82 mm; udźwig do: 80 kg

5902143102540



Kreda biała małopyląca

White chalk
Мел белый
Weiße Kreide
Krieda biela



Nr. ref.

Dane techniczne

Kod EAN

CON-KZ-BB50

50 szt.

5902143142645



Kreda biała niebrudząca

White chalk
Мел белый
Weiße Kreide
Krieda biela



Nr. ref.

Dane techniczne

Kod EAN

CON-KZ-MB12

12 szt.

5902143142652



Nóż uniwersalny wzmocniony

Retractable cutter, heavy duty
Нож универсальный
Cuttermesser
Nôž ulamovací univerzálny



Nr. ref.

Dane techniczne

Kod EAN

CON-8422

18 mm

5902143127444



Ostrza wymienne do noży tapetowych

Set of replacement blades
 Набор сменных лезвий для ножей для обоев
 Wechselschneiden für Tapetenmesser
 Výmenné čepele do tapetových nožův



Nr. ref.	Dane techniczne	Kod EAN
CON-9123	18 mm	5902143134657



Nóż z ostrzem łamającym

Snap-off knife
 Нож с отламываемым лезвием
 Cuttermesser
 Nóż ulamovací



Nr. ref.	Dane techniczne	Kod EAN
CON-UK-N1	18 mm	5902143131601



Noże uniwersalne

Retractable cutters
 Ножи универсальные
 Cuttermesser
 Nože ulamovacie univerzálne



Nr. ref.	Dane techniczne	Kod EAN
CON-9128	9 mm, 18 mm; 2 szt.	5902143127598



Nóż do tapet

Retractable cutter
 Нож для обоев
 Tapetenmesser
 Nóż do tapiet



Nr. ref.	Dane techniczne	Kod EAN
CON-9129	18 mm	5902143119104



Noże uniwersalne i skrobaki plastikowe

Retractable cutters and plastic scrapers
 Ножи универсальные и пластмассовые скребки
 Universal messerset
 Nože ulamovacie a škrabky



Nr. ref.	Dane techniczne	Kod EAN
CON-9132	8 szt.	5902143127369



Nóż z ostrzem łamającym

Snap-off knife
 Нож с отламываемым лезвием
 Cuttermesser
 Nóż ulamovací



Nr. ref.	Dane techniczne	Kod EAN
CON-UK-N2	9 mm	5902143131618



Nożyce do blach lewe

Tin snips, left cut
 Ножницы по металлу, левые
 Blechschere, links
 Nožnice na plech ľavé



Nr. ref.	Dane techniczne	Kod EAN
CON-NB-01	250 mm	5902143118664



Nożyce do blach prawe

Tin snips, right cut
Ножницы по металлу, правые
Blechscherer, rechts
Nožnice na plech pravé



Nr. ref.	Dane techniczne	Kod EAN
CON-NB-02	250 mm	5902143118671



Nożyce do blach proste

Tin snips, straight cut
Ножницы по металлу, прямые
Blechscherer, gerade
Nožnice na plech rovné



Nr. ref.	Dane techniczne	Kod EAN
CON-NB-03	250 mm	5902143118688



Nożyce do blach typ „angielski”

Tin snips, English type
Ножницы по металлу английского типа
Blechscherer Typ „englisch”
Nožnice na plech typ „anglický”



Nr. ref.	Dane techniczne	Kod EAN
CON-NB-04	250 mm	5902143118695



Nożyce do blach

Tin snips
Ножницы по металлу
Blechscherer
Nožnice na plech



Nr. ref.	Dane techniczne	Kod EAN
CON-NB-05	225 mm	5902143118701
CON-NB-06	300 mm	5902143118718
CON-NB-07	260 mm	5902143118725
CON-NB-08	320 mm	5902143118732



Nożyce do cięcia prętów

Bolt cutter
Ножницы арматурные
Bolzenscherer
Kliešte štípacie na tyče a svorníky



Nr. ref.	Dane techniczne	Kod EAN
CON-NP-18	18" (450 mm)	5902143118589
CON-NP-24	24" (600 mm)	5902143118596
CON-NP-30	30" (750 mm)	5902143118602
CON-NP-36	36" (900 mm)	5902143118619
CON-NP-48	48" (1200 mm)	5902143128632



Piła włosowa

Fret saw frame
Пила волос
Laubsägebögen
Rám lupienkovej píly



Nr. ref.	Dane techniczne	Kod EAN
CON-FS-300	300 mm	5902143141709



Brzeczczoty do piły włosowej

Fret saw blades
Полотна для лобзика
Blätter für Laubsägebögen
Pílové lišty



Nr. ref.	Dane techniczne	Kod EAN
CON-FS-NR3	drobny ząb nr 3, 12 szt.	5902143141716
CON-FS-NR5	średni ząb nr 5, 12 szt.	5902143141723
CON-FS-NR7	gruby ząb nr 7, 12 szt.	5902143141730



Piła do metalu z brzeszczotem

Hacksaw frame
Ножовка с полотном
Bügel säge mit Blatt
Pílka na kov



Nr. ref.	Dane techniczne	Kod EAN
CON-HF-1711	150 mm	5902143142607

Piła kątowa

Mitre saw
Пила угловая
Winkelsäge
Píla uhlová



Nr. ref.	Dane techniczne	Kod EAN
CON-SM-S550	550 mm	5902143102601

Piła do metalu z brzeszczotem, plastikowa rączka

Hacksaw frame, plastic handle
Ножовка с полотном – ручка пластмассовая
Bügel säge mit Blatt
Pílka na kov



Nr. ref.	Dane techniczne	Kod EAN
CON-HF-1712	150 mm	5902143142614

Skrzynka uciosowa drewniana z piłką

Wooden mitre box with saw
Стуло деревянное с пилой
Gehrlade mit Säge
Pokosnica drevená s pílkou



Nr. ref.	Dane techniczne	Kod EAN
CON-SU-3908	300 mm	5902143122517

Brzeszczoty do cięcia metalu

Hacksaw blades
Полотна
Blatt Zu Bügel säge
Pílové lišty



Nr. ref.	Dane techniczne	Kod EAN
CON-HF-B150	150 mm; 10 szt.	5902143142621

Dłuta do drewna

Wood carving chisels
Стамески для резьбы по дереву
Bildhauerholzbeitel
Dláta do dreva



Nr. ref.	Dane techniczne	Kod EAN
CON-3930	6/12/18/24 mm; 4 szt.	5902143138587

Piła kabłąkowa ogrodnicza

Bow garden saw
Пила лучковая садовая
Gartenbogensäge
Oblúková píla záhradná



Nr. ref.	Dane techniczne	Kod EAN
CON-PS-F760	760 mm	5902143134213

Dłuta do drewna rzeźbiarskie

Wood carving chisels
Стамески для резьбы по дереву
Bildhauerholzbeitel
Dlata do drewna



Nr. ref.	Dane techniczne	Kod EAN
CON-DU-3936	6 szt.	5902143122548



Strug kątnik

Rabbet plane
Зензубель
Nuthobel
Hoblík rímsovník



Nr. ref.	Dane techniczne	Kod EAN
CON-ST240x30	240 x 30 mm	5902143121848



Ścisk stolarski typu F

F-clamp
Струбцина F-образная
F-Zwinge
Svorka stolárska F



Nr. ref.	Dane techniczne	Kod EAN
CON-CF-05015	50 x 150 mm	5902143137689
CON-CF-05020	50 x 200 mm	5902143137696
CON-CF-05025	50 x 250 mm	5902143137702
CON-CF-05030	50 x 300 mm	5902143137719
CON-CF-08030	80 x 300 mm	5902143137726
CON-CF-12030	120 x 300 mm	5902143137733
CON-CF-12050	120 x 500 mm	5902143137740
CON-CF-12080	120 x 800 mm	5902143137757
CON-CF-12100	120 x 1000 mm	5902143137764



Ścisk stolarski typu F

F-clamp
Струбцина F-образная
F-Zwinge
Svorka stolárska F



Nr. ref.	Dane techniczne	Kod EAN
CON-CF-S01	50 x 100 mm; 2 szt.	5902143137917
CON-CF-S02	50 x 150 mm; 2 szt.	5902143137924
CON-CF-S03	50 x 200 mm; 2szt	5902143140511



Ścisk stolarski typu G

G-clamp
Струбцина G-образная
G-Zwinge
Svorka stolárska G



Nr. ref.	Dane techniczne	Kod EAN
CON-CG-02	2"	5902143137887
CON-CG-03	3"	5902143137894
CON-CG-04	4"	5902143137900



Ścisk stolarski typu G

G-clamp
Струбцина G-образная
G-Zwinge
Svorka stolárska G



Nr. ref.	Dane techniczne	Kod EAN
CON-CG-02	2"	5902143137887
CON-CG-03	3"	5902143137894
CON-CG-04	4"	5902143137900



Ścisk stolarski typu G

G-clamp
Струбцина G-образная
G-Zwinge
Svorka stolárska G



Nr. ref.	Dane techniczne	Kod EAN
CON-CG-S01	1", 2", 3"; 3 szt.	5902143137771



Szczotki

Brushes
Щётки
Bürsten
Kefy



Nr. ref.	Dane techniczne	Kod EAN
CON-SR-0165	175 mm; 3 szt.	5902143122524



Ścisk sprężynowy

Spring clamp
Зажим пружинный
Federklammer
Svorka pružinová



Nr. ref.	Dane techniczne	Kod EAN
CON-KL-204	110 mm	5902143122302
CON-KL-205	160 mm	5902143122319
CON-KL-206	210 mm	5902143122326

Osełka owalna

Oval whetstone
Брусок для заточки овальный
Schleifstein oval
Oslička okrúhla



Nr. ref.	Dane techniczne	Kod EAN
CON-3938	230 x 36 x 13 mm	5902143139522



Osełka dwuwarstwowa

Whetstone
Брусок для заточки
Schleifstein
Oslička

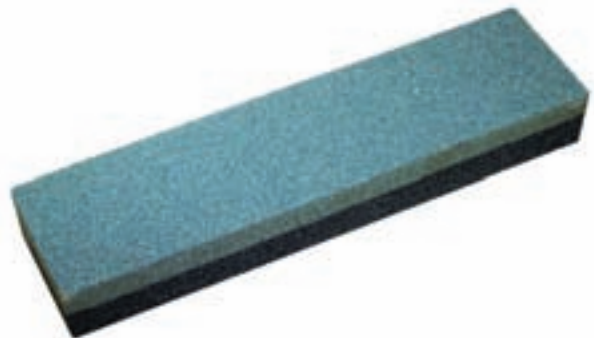

Nr. ref.	Dane techniczne	Kod EAN
CON-3940	200 x 50 x 25 mm	5902143107293



Szczotka druciana wygięta

Wire brush, bent
Щётка металлическая изогнутая
Drahtbürste gebogen
Kefa drôtená zahnutá



Nr. ref.	Kod EAN
CON-0016	5902143119050



Zszywki typu F

Upholstery staples
Скобы
Heftklammern
Spony do zošívacky

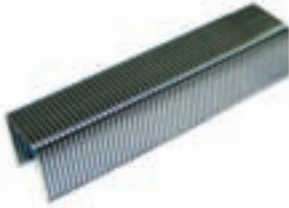

Nr. ref.	Dane techniczne	Kod EAN
CON-GTS-F04	4 mm; 1000 szt.	5902143147763
CON-GTS-F06	6 mm; 1000 szt.	5902143135166
CON-GTS-F08	8 mm; 1000 szt.	5902143135173
CON-GTS-F10	10 mm; 1000 szt.	5902143135180
CON-GTS-F12	12 mm; 1000 szt.	5902143135197
CON-GTS-F14	14 mm; 1000 szt.	5902143135203



Nity aluminiowe

Aluminium rivets
Заклёпки алюминиевые
Aluminiumnieten
Nity hliníkové



Nr. ref.	Dane techniczne	Kod EAN
CON-RVA-3,2	3,2 x 11,1 mm; 50 szt.	5902143117322
CON-RVA-4,0	4,0 x 12,7 mm; 50 szt.	5902143117339
CON-RVA-4,8	4,8 x 12,7 mm; 50 szt.	5902143117346



Nity aluminiowe

Aluminium rivets
Заклёпки алюминиевые
Aluminiumnieten
Nity hliníkové



Nr. ref.	Dane techniczne	Kod EAN
CON-RVA-3,2-5kg	3,2 x 11,1 mm, 5kg; 6250 szt.	5902143117292
CON-RVA-4,0-5kg	4,0 x 12,7 mm, 5kg; 2750 szt.	5902143117308
CON-RVA-4,8-5kg	4,8 x 12,7 mm, 5kg; 2250 szt.	5902143117315



Uchwyt lutowniczy „trzecia ręka”

Third hand soldering station
Держатель для паяльника типа «третья рука» 62 мм
Löthalter
Úchyt spájkový „tretia ruka”



Nr. ref.	Dane techniczne	Kod EAN
CON-UL-05	62 mm	5902143122586



Lutownica transformatorowa

Soldering gun
Паяльник
Lotpistole
Spájkovačka transformátorová



Nr. ref.	Dane techniczne	Kod EAN
CON-LUT-100	100 W	5902143138334



Lutownica transformatorowa z akcesoriami

Soldering gun with accessories
Паяльник с трансформатором 100 Вт
Lotpistole
Spájkovačka transformátorová



Nr. ref.	Dane techniczne	Kod EAN
CON-LUT-150	100 W	5902143119425



Palnik dekarski jednodyszowy

Roofing torch
Горелка кровельная
Anwärm Brenner
Opaľovací horák



Nr. ref.	Dane techniczne	Kod EAN
CON-PL-150	długość lancy 260 mm	5902143147824



Lutownice transformatorowa i oporowa z akcesoriami

Soldering gun with accessories
Паяльники
Lotpistole-Lötkolben
Spájkovačka transformátorová



Nr. ref.	Dane techniczne	Kod EAN
CON-LUT-200	100 W; 4 szt.; moc drugiego urządzenia: 40 W	5902143138341



Palnik lutowniczy z trzema dyszami

Brazing burner with 3 torches
Горелка для пайки - 3 форсунки
Gas Hartlötbrenner - 3 Düsen
Hořák letovaci/opaľovací - 3 nástavce



Nr. ref.	Dane techniczne	Kod EAN
CON-PL-109	długość lancy 260 mm	5902143142720

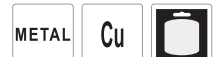

Drut spawalniczy

Welding wire
Проволока сварочная
Schweißdraht
Drôt zváračský



Nr. ref.	Dane techniczne	Kod EAN
CON-WW-0805	0,8 mm, 5 kg	5902143147787
CON-WW-0815	0,8 mm, 15 kg	5902143147794
CON-WW-1015	1,0 mm, 15 kg	5902143147800
CON-WW-1215	1,2 mm, 15 kg	5902143147817



Wyciskacz rynnowy do mas

Caulking gun
Пистолет для герметика
Kartuschenpistole
Pištol na tmel



Nr. ref.	Kod EAN
CON-9685	5902143135296

Wyciskacz szkieletowy do mas

Caulking gun
 Пистолет для герметика
 Kartuschenpistole
 Pištoľ na tmel



Nr. ref.

CON-9686

Kod EAN

5902143118657

Pistolet do piany montażowej

PU foam gun
 Пистолет для монтажной пены
 Montageschaumpistole
 Pištoľ do montážnej peny



Nr. ref.

CON-GF-02

Kod EAN

5902143147749

Pistolet do kleju z wyłącznikiem

Glue gun with switch
 Пистолет клеевой
 Heissklebepistole
 Pištoľ na tavná lepidla



Nr. ref.

CON-9900

Dane techniczne

11 mm, 220V, 60 W

Kod EAN

5902143111887



Pistolet do kleju

Glue gun
 Пистолет клеевой
 Heissklebepistole
 Pištoľ na tavná lepidla



Nr. ref.

CON-KP-G10

Dane techniczne

8,0 mm, 10 W

Kod EAN

5902143138365



Pistolet do kleju z aluminiową końcówką pokrytą tworzywem

Glue gun with aluminium head
 Пистолет клеевой
 Heissklebepistole
 Pištoľ na tavná lepidla



Nr. ref.

CON-KP-G60

Dane techniczne

11,2 mm, 60 W

Kod EAN

5902143138167



Pistolet do kleju z zapasowym wkładem

Glue gun with additional glue

Пистолет клеевой

Heissklebepistole

Pišťoľ na tavná lepidla



Nr. ref.	Dane techniczne	Kod EAN
CON-KP-S01	60 W; 11 mm, 220 V	5902143138174



Wkłady klejowe

Glue gun refill

Стержни клеевые

Klebesticks

Tavné tyčinky



Nr. ref.	Dane techniczne	Kod EAN
CON-KP-B0805	8,0 x 50 mm; 12 szt.	5902143138181
CON-KP-B1110	11,2 x 100 mm; 6 szt.	5902143138198
CON-KP-B1125	11,2 x 250 mm; 12 szt.	5902143138204
CON-KP-11120	11,2 x 200 mm; 50 szt.	5902143138211
CON-KP-21120	11,2 x 200 mm; 100 szt.	5902143138228
CON-KP-21130	11,2 x 300 mm; 65 szt.	5902143138235



Wózek składany

Foldable 4 wheel trolley
Тележка складная
Plattformwagen
Vozík se sklupným řelem



Nr. ref.	Dane techniczne	Kod EAN
CON-9984	udźwig do 75 kg	5902143111221



Wózek 2-kołowy

2 wheel trolley
Тележка 2-колёсная
Wagen 2 Räder
Vozík 2-kolesový



Nr. ref.	Dane techniczne	Kod EAN
CON-9987	udźwig do 250 kg	5902143116837



Wózek 4-kołowy

4 wheel trolley
Тележка 4-колёсная
Wagen 4 Räder
Vozík 4-kolesový



Nr. ref.	Dane techniczne	Kod EAN
CON-9985	udźwig do 150 kg	5902143102519
CON-9988	udźwig do 250 kg	5902143113126
CON-9986	udźwig do 300 kg	5902143110767



Kółka zapasowe do wózka

Replacement trolley wheels
Запасные колеса
Ersatzrädern
Náhradné kolesá



Nr. ref.	Dane techniczne	Kod EAN
CON-9987-K	9987; 2 szt.	5902143142294



Kółka zapasowe do wózka

Replacement trolley wheels
Запасные колеса
Ersatzrädern
Náhradné kolesá



Nr. ref.	Dane techniczne	Kod EAN
CON-9985-K	9985; 4 szt.	5902143132493
CON-9986-K	9986; 4 szt.	5902143142287



Wózek bagażowy składany

Folding luggage cart
Тележка багажная складная
Kofferwagen klappbar
Vozík sklupaný batožinový



Nr. ref.	Dane techniczne	Kod EAN
CON-9991	udźwig do 40 kg	5902143119531



Wózek 6-kołowy schodowy

6 wheel stair climber trolley
Тележка для лестниц 6-колёсная
Treppenwagen 6 Räder
Vozík schodový 6-kolesový



Nr. ref.	Dane techniczne	Kod EAN
CON-9989	udźwíg do 75 kg	5902143113119



Kółka zapasowe do wózka

Replacement trolley wheels
Запасные колеса
Ersatzrädern
Náhradné kolesá



Nr. ref.	Dane techniczne	Kod EAN
CON-9989-K	9989; 2 szt.	5902143142409



Wózek 4-kołowy aluminiowy

4 wheel aluminium trolley
Тележка алюминиевая 4-колёсная
Alu-Wagen 4 Räder
Vozík hliníkový 4-kolesový



Nr. ref.	Dane techniczne	Kod EAN
CON-9990	udźwíg do 350 kg	5902143130833



Skrzynka narzędziowa

Toolbox
Кейс для инструментов
Werkzeugkasten
Debnička na náradie



Nr. ref.	Dane techniczne	Kod EAN
CON-TB-12	12"	5902143132332
CON-TB-15	15"	5902143132349



Skrzynka narzędziowa

Toolbox
Кейс для инструментов
Werkzeugkasten
Debnička na náradie



Nr. ref.	Dane techniczne	Kod EAN
CON-TB-18	18"	5902143132356
CON-TB-22	22"	5902143132363



Rękawice robocze materiałowo/skórzane

Safety gloves, fabric/leather
 Рукавицы рабочие из ткани/кожи
 Schutzhandschuhe Textil/Leder
 Rukavice pracovné materiálovo-kožené



Nr. ref.
9965

Kod EAN
5902143133667



Okulary przeciwoodpryskowe białe

Safety goggles, white
 Очки защитные противоосколочные, белые
 Spritzschutzbrille, weiß
 Ochranné okuliare



Nr. ref.
CON-9730

Kod EAN
5902143125556



Maski przeciwpyłowe z zaworkiem

Dust masks with valve
 Респираторы противопыльные с клапаном
 Staubschutzmasken mit Ventil
 Protiprašné masky s ventilkom



Nr. ref.
CON-9726-2

Dane techniczne
FFP1; 2 szt.

Kod EAN
5902143125563



Słuchawki ochronne

Ear muffs
 Наушники защитные
 Gehörschutz
 Ochranné slúchadlá



Nr. ref.
CON-9731

Kod EAN
5902143123712



Maski przeciwpyłowe

FFP1 dust masks
 Респираторы противопыльные FFP1
 Staubschutzmasken FFP1
 Protiprašné masky FFP1



Nr. ref.
CON-9725-5

Dane techniczne
FFP1; 5 szt.

Kod EAN
5902143125570



Kamizelka ochronna

Safety vest
 Жилет защитный сигнальный
 Warnweste
 Vesta ochranná reflexná



Nr. ref.

Dane techniczne

Kod EAN

Kami-2-L	2 pasy odblaskowe - rozmiar L	5902143118756
Kami-2-XL	2 pasy odblaskowe - rozmiar XL	5902143119111
Kami-4-L	4 pasy odblaskowe - rozmiar L	5902143118763
Kami-4-XL	4 pasy odblaskowe - rozmiar XL	5902143119128



Miara zwijana

Measuring tape
Рулетка строительная
Rollbandmass
Meter zvinovací



Nr. ref.	Dane techniczne	Kod EAN
CON-3120	2 m x 12,5 mm	5902143125587
CON-3130	3 m x 16 mm	5902143125594
CON-3150	5 m x 19 mm	5902143125600



Kątownik z kątomierzem

Angle with protractor
Угломер универсальный
Universal-winkelmesser
Univerzálny uholník



Nr. ref.	Dane techniczne	Kod EAN
CON-10087	180o: 90 x 150 mm	5902143113492
CON-10088	180o: 230 x 500 mm	5902143113508



Miara zwijana

Measuring tape
Рулетка строительная
Rollbandmass
Meter zvinovací



Nr. ref.	Dane techniczne	Kod EAN
CON-MZ-3	3 m x 19 mm	5902143125617
CON-MZ-5	5 m x 19 mm	5902143125624
CON-MZ-7,5	7,5 m x 25 mm	5902143125631



Miernik cyfrowy uniwersalny

Digital multimeter
Мультиметр цифровой
Multifunktions-Messgerät
Multimeter digitálny



Nr. ref.	Kod EAN
CON-M26	5902143109334



Kątownik z kątomierzem

Angle with protractor
Угломер универсальный
Universal-winkelmesser
Univerzálny uholník



Nr. ref.	Dane techniczne	Kod EAN
CON-10087	180o: 90 x 150 mm	5902143113492



Wskaźnik napięcia

Voltage indicator
Индикатор напряжения
Spannungssucher
Ukazovateľ napätia



Nr. ref.	Dane techniczne	Kod EAN
CON-KK-140	140 mm	5902143119098
CON-KK-190	190 mm	5902143134930



Pasy do mocowania ładunku

Lashing straps
 Ремни для крепления груза
 Transportsicherungen Gurte
 Pás na upevnenie nákladu



Nr. ref.	Dane techniczne	Kod EAN
CON-RT-01	25 mm x 3,8 m; 2 szt.; max: 540 kg	5902143124887



Pasy do mocowania ładunku

Lashing straps
 Ремни для крепления груза
 Transportsicherungen Gurte
 Pás na upevnenie nákladu



Nr. ref.	Dane techniczne	Kod EAN
CON-RT-03	27 mm x 3,8 m; 2 szt.; max: 1000 kg	5902143124900



Pasy do mocowania ładunku

Lashing straps
 Ремни для крепления груза
 Transportsicherungen Gurte
 Pás na upevnenie nákladu



Nr. ref.	Dane techniczne	Kod EAN
CON-RT-02	50 mm x 6,8 m; 2 szt.; max: 5000 kg	5902143124894
CON-RT-06	50 mm x 8,0 m; 2 szt.; max: 5000 kg	5902143127925
CON-RT-07	50 mm x 10,0 m; 2 szt.; max: 5000 kg	5902143127932
CON-RT-08	50 mm x 12,0 m; 2 szt.; max: 5000 kg	5902143127949



Pasy do mocowania ładunku

Lashing straps
 Ремни для крепления груза
 Transportsicherungen Gurte
 Pás na upevnenie nákladu





Nr. ref.	Dane techniczne	Kod EAN
CON-RT-04	27 mm x 3,0 m; 2 szt.; max: 1200 kg	5902143124917



Pasy do mocowania ładunku

Lashing straps
Ремни для крепления груза
Transportsicherungen Gurte
Pás na upevnenie nákladu







Nr. ref.	Dane techniczne	Kod EAN
CON-RT-05	38 mm x 3,8 m; 2 szt.; max: 2000 kg	5902143124924
  		

Wciągarka łańcuchowa

Chain hoist
Лубёдка цепная
Kettenwinde
Navijak reťazový



Nr. ref.	Dane techniczne	Kod EAN
CON-VT-1T3M	waga 12,0 kg - 1 t/3 m	5902143121800
CON-VT-1T6M	waga 15,5 kg - 1 t/6 m	5902143121817
CON-VT-2T3M	waga 17,3 kg - 2 t/3 m	5902143121824
CON-VT-2T6M	waga 21,3 kg - 2 t/6 m	5902143121879
    		

Wyciągarka linowa z podwójnym kołem zębatym

Wire rope winch with dual gear
Лубёдка канатная с двойной зубчатой шестернёй
Bremswinde mit Seil, Doppelzahnrad
Navijak lanový s dvojitým ozubeným kolesom





Nr. ref.	Dane techniczne	Kod EAN
CON-WG-2T	2 t	5902143119142
CON-WG-4T	4 t	5902143119159
 		

Wyciągarka taśmowa z podwójnym kołem zębatym

Tape winch with dual gear
Лубёдка ленточная с двойной зубчатой шестернёй
Bandwinde, Doppelzahnrad
Navijak pásový s dvojitým ozubeným kolesom



Nr. ref.	Dane techniczne	Kod EAN
CON-WGB-T12	500 kg	5902143123194
CON-WGB-T20	900 kg	5902143123200
 		

Wyciągnik linowy

Wire rope winch
Таль канатная
Bremswinde mit Seil
Kladkostroj lanový



Nr. ref.	Dane techniczne	Kod EAN
CON-WG-T12	500 kg	5902143119135
CON-WG-T20	900 kg	5902143119258



Numerator literowy

Letter punches
Набор нумераторный - буквы, типа
Buchstaben-Stempelgerät
Razidlá s písmenami



Nr. ref.	Dane techniczne	Kod EAN
CON-NU-4-LI	4 mm; 27 szt.	5902143122203
CON-NU-5-LI	5 mm; 27 szt.	5902143122227
CON-NU-6-LI	6 mm; 27 szt.	5902143121428
CON-NU-8-LI	8 mm; 27 szt.	5902143121435



Ściągacz do łożysk 3-ramienny

3-leg puller
Съёмник подшипников 3-хлапный
Lagerabziehvorrichtung, 3 Arme
Stahovák ložísk 3-ramenný



Nr. ref.	Dane techniczne	Kod EAN
CON-BPU-3	75 mm	5902143121565
CON-BPU-4	100 mm	5902143121572
CON-BPU-6	150 mm	5902143121589
CON-BPU-8	200 mm	5902143122678
CON-BPU-10	250 mm	5902143122685
CON-BPU-12	300 mm	5902143122692



Numerator cyfrowy

Number punches
Набор нумераторный - цифры
Ziffer-Stempelgerät
Razidlá s číslicami



Nr. ref.	Dane techniczne	Kod EAN
CON-NU-4-CY	4 mm; 9 szt.	5902143122210
CON-NU-5-CY	5 mm; 9 szt.	5902143122234
CON-NU-6-CY	6 mm; 9 szt.	5902143121442
CON-NU-8-CY	8 mm; 9 szt.	5902143121008



Sznur
Cord
Шнур
Schnur
Šnúra



Nr. ref.	Dane techniczne	Kod EAN
CON-SN-47	50 m	5902143123842
CON-SN-48	80 m	5902143123859

Drut uniwersalny do mocowania Twist-Fix
Multi purpose Twist-Fix wire
Проволока для крепления Twist-Fix
Universalbefestigungsdraht Twist-Fix
Drôty univerzálne do pripevňovania Twist-Fix



Nr. ref.	Dane techniczne	Kod EAN
CON-TT-68	170 mm; 200 kg, 1 szt.	5902143122050
CON-TT-17	430 mm; 200 kg, 4 szt.	5902143122036
CON-TT-34	860 mm; 200 kg, 2 szt.	5902143122043



Drut ocynkowy
Galvanized wire
Проволока оцинкованная
Draht verzinkt
Drôt pozinkovaný

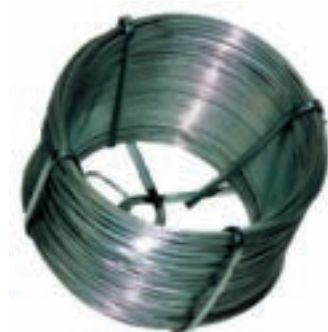

Nr. ref.	Dane techniczne	Kod EAN
CON-GW-0150	50 m	5902143134848

Drut powlekany PCV
PVC coated wire
Проволока с ПВХ покрытием
Draht PVC-beschichtet
Drôt obalený PVC



Nr. ref.	Dane techniczne	Kod EAN
CON-GW-0250	50 m	5902143134855

Spirala kanalizacyjna ocynkowana
Drain auger, galvanized
Сантехнический трос канатный, оцинкованный
Rohr-Reinigungsspirale, verzinkt
Pružina kanalizačná, pozinkovaná



Nr. ref.	Dane techniczne	Kod EAN
CON-SK-4/1,5	4 mm x 1,5 m	5902143120445
CON-SK-4/3	4 mm x 3,0 m	5902143122555
CON-SK-4/5	4 mm x 5,0 m	5902143120452
CON-SK-5/1,5	5 mm x 1,5 m	5902143135357
CON-SK-5/3	5 mm x 3,0 m	5902143122562
CON-SK-5/5	5 mm x 5,0 m	5902143111238
CON-SK-6/3	6 mm x 3,0 m	5902143122579
CON-SK-6/5	6 mm x 5,0 m	5902143120476
CON-SK-7/5	7 mm x 5,0 m	5902143147626
CON-SK-8/5	8 mm x 5,0 m	5902143111306
CON-SK-9/10	9 mm x 10 m	5902143111313
CON-SK-9/15	9 mm x 15 m	5902143111320
CON-SK-10/10	10 mm x 10 m	5902143140696
CON-SK-11/10	11 mm x 10 m	5902143111351
CON-SK-11/15	11 mm x 15 m	5902143147770



Pompka ręczna do udrażniania syfonów

Manual drain pump
 Ручной насос для сифона
 Handpumpe
 Pumpička ručná



Nr. ref.

CON-SKP-01

Kod EAN

5902143120490



GUMA

Nożyczki wieloczynnościowe

Multipurpose scissors
 Ножницы многофункциональные
 Mehrzweckschere
 Nožničky viacfunkčné



Nr. ref.

CON-9114

Kod EAN

5902143134695

Sprężyna kanalizacyjna półautomatyczna

Drain auger, half-automatic
 Ручная вертушка с автоподачей
 Rohrreinigungs Spirale, halbautomatisch
 Pružina kanalizačná, poloautomatická



Nr. ref.

CON-SKPA-3

Dane techniczne

6 mm x 3 m

Kod EAN

5902143117858

CON-SKPA-5

6 mm x 5 m

5902143117865



Filtr do wody

Water filter
 Водяной фильтр
 Wasserfilter
 Vodný filter



Nr. ref.

CON-FW-01

Dane techniczne

średnice przyłączy - 3/4"

Kod EAN

5902143116691

Przycinak dwustronny do krawędzi okleinowych

Veneer cutter, two-sided
 Подрезатель кромки двухсторонний
 Ausklinker für Möbelkanten doppelseitig
 Ručná kapovačka



Nr. ref.

CON-ET-02

Dane techniczne

13-25 mm

Kod EAN

5902143123217

